

# MLX90614 family

## Datasheet Single and Dual Zone Infra Red Thermometer in TO-39

### Features and Benefits

- Small size, low cost
- Easy to integrate
- Factory calibrated in wide temperature range:  
-40°C...+125°C for sensor temperature and  
-70°C...+380°C for object temperature.
- High accuracy of 0.5°C in a wide temperature range (0°C...+50°C for both Ta and To)
- High (medical) accuracy calibration
- Measurement resolution of 0.02°C
- Single and dual zone versions
- SMBus compatible digital interface
- Customizable PWM output for continuous reading
- Available in 3V and 5V versions
- Simple adaptation for 8V...16V applications
- Sleep mode for reduced power consumption
- Different package options for applications and measurements versatility
- Automotive grade

### Application Examples

- High precision non-contact temperature measurements
- Thermal Comfort sensor for Mobile Air Conditioning control system
- Temperature sensing element for residential, commercial and industrial building air conditioning
- Windshield defogging
- Automotive blind angle detection
- Industrial temperature control of moving parts
- Temperature control in printers and copiers
- Home appliances with temperature control
- Healthcare
- Livestock monitoring
- Movement detection
- Multiple zone temperature control – up to 127 sensors can be read via common 2 wires
- Thermal relay / alert
- Body temperature measurement

### Ordering Information



Part No.	Temperature Code	Package Code	- Option Code	Standard part	Packing form
MLX90614	E (-40°C...85°C) K (-40°C...125°C)	SF (TO-39)	- X X X (1) (2) (3)	-000	-TU

(1) Supply Voltage/ Accuracy  
A - 5V  
B - 3V  
C - Reserved  
D - 3V medical accuracy

(2) Number of thermopiles:  
A - single zone  
B - dual zone  
C - gradient compensated\*

(3) Package options:  
A - Standard package  
B - Reserved  
C - 35° FOV  
D/E - Reserved  
F - 10° FOV  
G - Reserved  
H - 12° FOV (refractive lens)  
I - 5° FOV  
K - 13° FOV

**Example:**

MLX90614ESF-BAA-000-TU \* : See page 2

## 1. Functional diagram

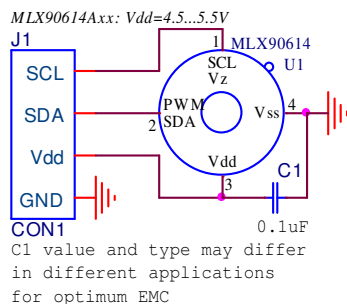

### **MLX90614 connection to SMBus**

Figure 1: Typical application schematics

The MLX90614 is built from 2 chips developed and manufactured by Melexis:

- The Infra Red thermopile detector MLX81101
- The signal conditioning ASSP MLX90302, specially designed to process the output of IR sensor.

The device is available in an industry standard TO-39 package.

Thanks to the low noise amplifier, high resolution 17-bit ADC and powerful DSP unit of MLX90302 high accuracy and resolution of the thermometer is achieved. The calculated object and ambient temperatures are available in RAM of MLX90302 with resolution of 0.01°C. They are accessible by 2 wire serial SMBus compatible protocol (0.02°C resolution) or via 10-bit PWM (Pulse Width Modulated) output of the device.

The MLX90614 is factory calibrated in wide temperature ranges: -40°C...125°C for the ambient temperature and -70°C...380°C for the object temperature.

The measured value is the average temperature of all objects in the Field Of View of the sensor. The MLX90614 offers a standard accuracy of  $\pm 0.5^\circ\text{C}$  around room temperatures. A special version for medical applications exists offering an accuracy of  $\pm 0.2^\circ\text{C}$  in a limited temperature range around the human body temperature.

It is very important for the application designer to understand that these accuracies are only guaranteed and achievable when the sensor is in thermal equilibrium and under isothermal conditions (there are no temperature differences across the sensor package). The accuracy of the thermometer can be influenced by temperature differences in the package induced by causes like (among others): Hot electronics behind the sensor, heaters/coolers behind or beside the sensor or by a hot/cold object very close to the sensor that not only heats the sensing element in the thermometer but also the thermometer package.

This effect is especially relevant for thermometers with a small FOV like the xxC and xxF as the energy received by the sensor from the object is reduced. Therefore, Melexis has introduced the xCx version of the MLX90614. In these MLX90614xCx, the thermal gradients are measured internally and the measured temperature is compensated for them. In this way, the xCx version of the MLX90614 is much less sensitive to thermal gradients, but the effect is not totally eliminated. It is therefore important to avoid the causes of thermal gradients as much as possible or to shield the sensor from them.

As a standard, the MLX90614 is calibrated for an object emissivity of 1. It can be easily customized by the customer for any other emissivity in the range 0.1...1.0 without the need of recalibration with a black body.

The 10-bit PWM is as a standard configured to transmit continuously the measured object temperature for an object temperature range of -20°C...120°C with an output resolution of 0.14°C. The PWM can be easily customized for virtually any range desired by the customer by changing the content of 2 EEPROM cells. This has no effect on the factory calibration of the device.

## 2. General Description

The MLX90614 is an Infra Red thermometer for non-contact temperature measurements. Both the IR sensitive thermopile detector chip and the signal conditioning ASSP are integrated in the same TO-39 can. Thanks to its low noise amplifier, 17-bit ADC and powerful DSP unit, a high accuracy and resolution of the thermometer is achieved.

The thermometer comes factory calibrated with a digital PWM and SMBus (System Management Bus) output.

As a standard, the 10-bit PWM is configured to continuously transmit the measured temperature in range of -20...120°C, with an output resolution of 0.14°C. The factory default POR setting is SMBus.

## MLX90614 family

Single and Dual Zone

Infra Red Thermometer in TO-39

The PWM pin can also be configured to act as a thermal relay (input is To), thus allowing for an easy and cost effective implementation in thermostats or temperature (freezing / boiling) alert applications. The temperature threshold is user programmable. In a SMBus system this feature can act as a processor interrupt that can trigger reading all slaves on the bus and to determine the precise condition.

The thermometer is available in 2 supply voltage options: 5V compatible or 3V (battery) compatible. The 5V can be easily adopted to operate from a higher supply voltage (8...16V, for example) by use of few external components (refer to "Applications information" section for details).

An optical filter (long-wave pass) that cuts off the visible and near infra-red radiant flux is integrated in the package to provide ambient and sunlight immunity. The wavelength pass band of this optical filter is from 5.5...14 $\mu$ m (except for xCH and xCI type of devices which incorporate uncoated silicon lens).



### 3. Contents

Features and Benefits.....	1
Application Examples .....	1
Ordering Information .....	1
1. Functional diagram.....	2
2. General Description.....	2
3. Contents.....	4
4. Glossary of Terms.....	7
5. Maximum ratings.....	7
6. Pin definitions and descriptions.....	8
7. Electrical Specifications .....	9
7.1. MLX90614Axx .....	9
7.2. MLX90614Bxx, MLX90614Dxx.....	11
8. Detailed description .....	13
8.1. Block diagram.....	13
8.2. Signal processing principle .....	13
8.3. Block description.....	14
8.3.1. Amplifier.....	14
8.3.2. Supply regulator and POR.....	14
8.3.3. EEPROM .....	14
8.3.4. RAM .....	17
8.4. SMBus compatible 2-wire protocol .....	17
8.4.1. Functional description.....	17
8.4.2. Differences with the standard SMBus specification (reference [1]).....	18
8.4.3. Detailed description .....	18
8.4.4. Bit transfer .....	19
8.4.5. Commands .....	20
8.4.6. SMBus communication examples.....	20
8.4.7. Timing specification .....	21
8.4.8. Sleep Mode .....	22
8.4.9. MLX90614 SMBus specific remarks.....	23
8.5. PWM.....	24

8.5.1. Single PWM format.....	25
8.5.2. Extended PWM format.....	26
8.5.3. Customizing the temperature range for PWM output.....	27
8.6. Switching Between PWM / Thermal relay and SMBus communication.....	29
8.6.1. PWM is enabled.....	29
8.6.2. Request condition.....	29
8.6.3. PWM is disabled.....	29
8.7. Computation of ambient and object temperatures.....	30
8.7.1. Ambient temperature $T_a$ .....	30
8.7.2. Object temperature $T_o$ .....	30
8.7.3. Calculation flow.....	31
8.8. Thermal relay.....	32
<b>9. Unique Features.....</b>	<b>33</b>
<b>10. Performance Graphs.....</b>	<b>34</b>
10.1. Temperature accuracy of the MLX90614.....	34
10.1.1. Standard accuracy.....	34
10.1.2. Medical accuracy.....	36
10.1.3. Temperature reading dependence on VDD.....	36
10.2. Field Of View (FOV).....	38
<b>11. Applications Information.....</b>	<b>42</b>
11.1. Use of the MLX90614 thermometer in SMBus configuration.....	42
11.2. Use of multiple MLX90614s in SMBus configuration.....	42
11.3. PWM output operation.....	42
11.4. Thermal alert / thermostat.....	43
11.5. High voltage source operation.....	44
<b>12. Application Comments.....</b>	<b>45</b>
<b>13. Standard information regarding manufacturability of Melexis products with different soldering processes.....</b>	<b>47</b>
<b>14. ESD Precautions.....</b>	<b>47</b>
<b>15. FAQ.....</b>	<b>48</b>
<b>16. Package Information.....</b>	<b>50</b>
16.1. MLX90614xxA.....	50
16.2. MLX90614xCC.....	50



**MLX90614 family**

Single and Dual Zone  
Infra Red Thermometer in TO-39

16.3. MLX90614xCF .....51  
16.4. MLX90614xCH.....51  
16.5. MLX90614xCI .....52  
16.6. MLX90614xCK .....52  
16.7. Part marking.....53  
16.8. Operating and storage humidity range .....53  
**17. Table of figures..... 54**  
**18. References..... 55**  
**19. Contact..... 56**  
**20. Disclaimer..... 56**



## 4. Glossary of Terms

PTAT	<b>Proportional To Absolute Temperature</b> sensor (package temperature)
POR	<b>Power On Reset</b>
HFO	<b>High Frequency Oscillator</b> (RC type)
DSP	<b>Digital Signal Processing</b>
FIR	<b>Finite Impulse Response</b> . Digital filter
IIR	<b>Infinite Impulse Response</b> . Digital filter
IR	<b>Infra-Red</b>
PWM	<b>Pulse With Modulation</b>
DC	<b>Duty Cycle</b> (of the PWM) ; <b>Direct Current</b> (for settled conditions specifications)
FOV	<b>Field Of View</b>
SDA,SCL	<b>Serial DA</b> tA, <b>Serial CL</b> oCK – SMBus compatible communication pins
T <sub>a</sub>	<b>Ambient Temperature</b> measured from the chip – (the package temperature)
T <sub>o</sub>	<b>Object Temperature</b> , ‘seen’ from IR sensor
ESD	<b>Electro-Static Discharge</b>
EMC	<b>Electro-Magnetic Compatibility</b>
ASSP	<b>Application Specific Standard Product</b>
TBD	<b>To Be Defined</b>

*Note: sometimes the MLX90614xxx is referred as “the module”.*

## 5. Maximum ratings

Parameter	MLX90614ESF-Axx	MLX90614ESF-Bxx MLX90614ESF-Dxx	MLX90614KSF-Axx
Supply Voltage, V <sub>DD</sub> (over voltage)	7V	5V	7V
Supply Voltage, V <sub>DD</sub> (operating)	5.5 V	3.6V	5.5V
Reverse Voltage	0.4 V		
Operating Temperature Range, T <sub>A</sub>	-40°C...+85°C		-40°C...+125°C
Storage Temperature Range, T <sub>S</sub>	-40°C...+125°C		-40°C...+125°C
ESD Sensitivity (AEC Q100 002)	2kV		
DC current into SCL / Vz (Vz mode)	2 mA		
DC sink current, SDA / PWM pin	25 mA		
DC source current, SDA / PWM pin	25 mA		
DC clamp current, SDA / PWM pin	25 mA		
DC clamp current, SCL pin	25 mA		

*Table 1: Absolute maximum ratings for MLX90614*

Exceeding the absolute maximum ratings may cause permanent damage.  
Exposure to absolute-maximum-rated conditions for extended periods may affect device reliability.

## 6. Pin definitions and descriptions

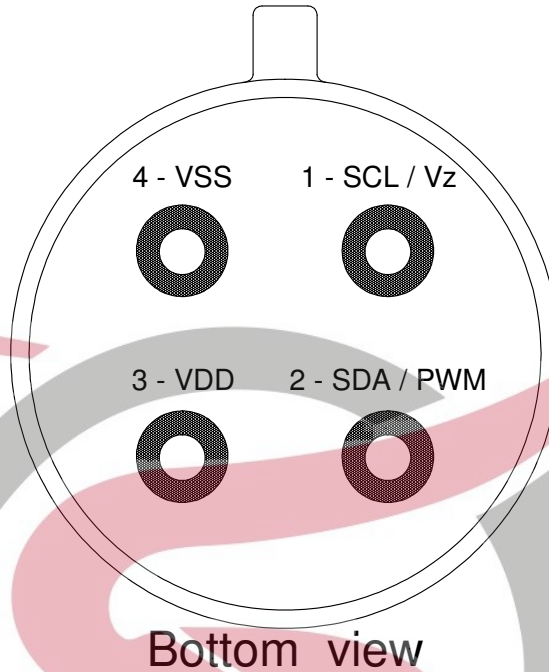

Figure 2: Pin description

Pin Name	Function
<b>SCL / Vz</b>	Serial clock input for 2 wire communications protocol. 5.7V zener is available at this pin for connection of external bipolar transistor to MLX90614Axx to supply the device from external 8...16V source.
<b>SDA / PWM</b>	Digital input / output. In normal mode the measured object temperature is available at this pin Pulse Width Modulated. In SMBus compatible mode the pin is automatically configured as open drain NMOS.
<b>VDD</b>	External supply voltage.
<b>VSS</b>	Ground. The metal can is also connected to this pin.

Table 2: Pin description MLX90614

*Note: for +12V (+8...+16V) powered operation refer to the Application information section. For EMC and isothermal conditions reasons it is highly recommended not to use any electrical connection to the metal can except by the VSS pin. With the SCL / Vz and PWM / SDA pins operated in 2-wire interface mode, the input Schmidt trigger function is automatically enabled.*



## 7. Electrical Specifications

### 7.1. MLX90614Axx

All parameters are valid for  $T_A = 25\text{ }^\circ\text{C}$ ,  $V_{DD} = 5\text{V}$  (unless otherwise specified)

Parameter	Symbol	Test Conditions	Min	Typ	Max	Units
<b>Supplies</b>						
External supply	$V_{DD}$		4.5	5	5.5	V
Supply current	$I_{DD}$	No load		1.3	2	mA
Supply current (programming)	$I_{DDpr}$	No load, erase/write EEPROM operations		1.5	2.5	mA
Zener voltage	$V_Z$	$I_Z = 75\text{...}1000\mu\text{A}$ ( $T_A = \text{room}$ )	5.5	5.7	5.9	V
Zener voltage	$V_Z(T_A)$	$I_Z = 70\text{...}1000\mu\text{A}$ , full temperature range	5.15	5.7	6.24	V
<b>Power On Reset</b>						
POR level	$V_{POR\_up}$	Power-up (full temp range)	1.4	1.75	1.95	V
POR level	$V_{POR\_down}$	Power-down (full temp range)	1.3	1.7	1.9	V
POR hysteresis	$V_{POR\_hys}$	Full temp range	0.08	0.1	1.15	V
$V_{DD}$ rise time (10% to 90% of specified supply voltage)	$T_{POR}$	Ensure POR signal			20	ms
Output valid (result in RAM)	$T_{valid}$	After POR		0.25		s
<b>Pulse width modulation<sup>1</sup></b>						
PWM resolution	$PWM_{res}$	Data band		10		bit
PWM output period	$PWM_{T,def}$	Factory default, internal oscillator factory calibrated		1.024		ms
PWM period stability	$dPWM_T$	Internal oscillator factory calibrated, over the entire operation range and supply voltage	-10		+10	%
Output high Level	$PWM_{HI}$	$I_{source} = 2\text{ mA}$	$V_{DD}-0.2$			V
Output low Level	$PWM_{LO}$	$I_{sink} = 2\text{ mA}$			$V_{SS}+0.2$	V
Output drive current	$I_{drive\_PWM}$	$V_{out,H} = V_{DD} - 0.8\text{V}$		7		mA
Output sink current	$I_{sink\_PWM}$	$V_{out,L} = 0.8\text{V}$		13.5		mA

Continued on next page

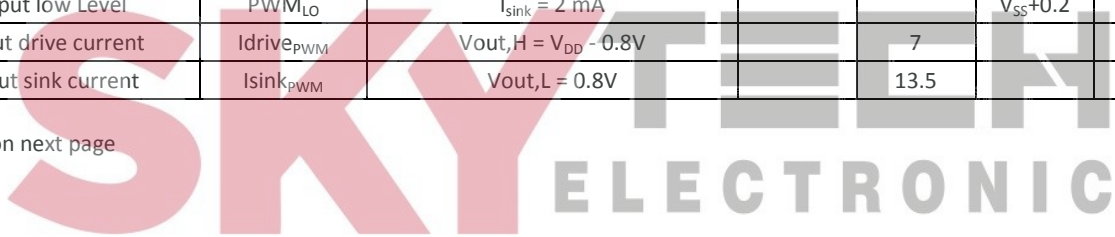

Parameter	Symbol	Test Conditions	Min	Typ	Max	Units
<b>SMBus compatible 2-wire interface<sup>2</sup></b>						
Input high voltage	$V_{IH}(Ta, V)$	Over temperature and supply	3			V
Input low voltage	$V_{IL}(Ta, V)$	Over temperature and supply			0.6	V
Output low voltage	$V_{OL}$	Over temperature and supply, $I_{sink} = 2mA$			0.2	V
SCL leakage	$I_{SCL, leak}$	$V_{SCL}=4V, Ta=+85^{\circ}C$			30	$\mu A$
SDA leakage	$I_{SDA, leak}$	$V_{SDA}=4V, Ta=+85^{\circ}C$			0.3	$\mu A$
SCL capacitance	$C_{SCL}$				10	pF
SDA capacitance	$C_{SDA}$				10	pF
Slave address	SA	Factory default		5A		hex
Wake up request	$t_{wake}$	SDA low	33			ms
SMBus Request	$t_{REQ}$	SCL low	1.44			ms
Timeout, low	$T_{imeout,L}$	SCL low	27		33	ms
Timeout, high	$T_{imeout,H}$	SCL high	45		55	$\mu s$
Acknowledge setup time	$T_{suac}(MD)$	8-th SCL falling edge, Master			1.5	$\mu s$
Acknowledge hold time	$T_{hdac}(MD)$	9-th SCL falling edge, Master			1.5	$\mu s$
Acknowledge setup time	$T_{suac}(SD)$	8-th SCL falling edge, Slave			2.5	$\mu s$
Acknowledge hold time	$T_{hdac}(SD)$	9-th SCL falling edge, Slave			1.5	$\mu s$
<b>EEPROM</b>						
Data retention		$Ta = +85^{\circ}C$	10			years
Erase/write cycles		$Ta = +25^{\circ}C$	100,000			Times
Erase/write cycles		$Ta = +125^{\circ}C$	10,000			Times
Erase cell time	$T_{erase}$			5		ms
Write cell time	$T_{write}$			5		ms

Table 3: Electrical specification MLX90614Axx

Notes: All the communication and refresh rate timings are given for the nominal calibrated HFO frequency and will vary with this frequency's variations.

1. With large capacitive load lower PWM frequency is recommended. Thermal relay output (when configured) has the PWM DC specification and can be programmed as push-pull, or NMOS open drain. PWM is free-running, power-up factory default is SMBus, refer to section 8.6, "Switching between PWM and SMBus communication" for more details.

2. For SMBus compatible interface on 12V application refer to Application information section. SMBus compatible interface is described in details in the SMBus detailed description section. Maximum number of MLX90614 devices on one bus is 127, higher pull-up currents are recommended for higher number of devices, faster bus data transfer rates, and increased reactive loading of the bus.

MLX90614 is always a slave device on the bus. MLX90614 can work in both low-power and high-power SMBus communication.

All voltages are referred to the  $V_{ss}$  (ground) unless otherwise noted.

Sleep mode is not available on the 5V version (MLX90614Axx).

## 7.2. MLX90614Bxx, MLX90614Dxx

All parameters are valid for  $T_A = 25\text{ }^\circ\text{C}$ ,  $V_{DD} = 3\text{V}$  (unless otherwise specified)

Parameter	Symbol	Test Conditions	Min	Typ	Max	Units
<b>Supplies</b>						
External supply	$V_{DD}$		2.6	3	3.6	V
Supply current	$I_{DD}$	No load		1.3	2	mA
Supply current (programming)	$I_{DDpr}$	No load, erase / write EEPROM operations		1.5	2.5	mA
Sleep mode current	$I_{sleep}$	no load	1	2.5	5	$\mu\text{A}$
Sleep mode current	$I_{sleep}$	Full temperature range	1	2.5	6	$\mu\text{A}$
<b>Power On Reset</b>						
POR level	$V_{POR\_up}$	Power-up (full temp range)	1.4	1.75	1.95	V
POR level	$V_{POR\_down}$	Power-down (full temp range)	1.3	1.7	1.9	V
POR hysteresis	$V_{POR\_hys}$	Full temp range	0.08	0.1	1.15	V
$V_{DD}$ rise time (10% to 90% of specified supply voltage)	$T_{POR}$	Ensure POR signal			20	ms
Output valid	$T_{valid}$	After POR		0.25		s
<b>Pulse width modulation<sup>1</sup></b>						
PWM resolution	PWMres	Data band		10		bit
PWM output period	$PWM_{T,def}$	Factory default, internal oscillator factory calibrated		1.024		ms
PWM period stability	$dPWM_T$	Internal oscillator factory calibrated, over the entire operation range and supply voltage	-10		+10	%
Output high Level	$PWM_{HI}$	$I_{source} = 2\text{ mA}$	$V_{DD}-0.25$			V
Output low Level	$PWM_{LO}$	$I_{sink} = 2\text{ mA}$			$V_{SS}+0.25$	V
Output drive current	$I_{drive\_PWM}$	$V_{out,H} = V_{DD} - 0.8\text{V}$		4.5		mA
Output sink current	$I_{sink\_PWM}$	$V_{out,L} = 0.8\text{V}$		11		mA

Continued on next page



## MLX90614 family

Single and Dual Zone  
Infra Red Thermometer in TO-39

Parameter	Symbol	Test Conditions	Min	Typ	Max	Units
<b>SMBus compatible 2-wire interface<sup>2</sup></b>						
Input high voltage	$V_{IH}(Ta,V)$	Over temperature and supply	VDD-0.1			V
Input low voltage	$V_{IL}(Ta,V)$	Over temperature and supply			0.6	V
Output low voltage	$V_{OL}$	Over temperature and supply, $I_{sink} = 2mA$			0.25	V
SCL leakage	$I_{SCL,leak}$	$V_{SCL}=3V, Ta=+85^{\circ}C$			20	$\mu A$
SDA leakage	$I_{SDA,leak}$	$V_{SDA}=3V, Ta=+85^{\circ}C$			0.25	$\mu A$
SCL capacitance	$C_{SCL}$				10	pF
SDA capacitance	$C_{SDA}$				10	pF
Slave address	SA	Factory default		5A		hex
Wake up request	$t_{wake}$	SDA low	33			ms
SMBus Request	$t_{REQ}$	SCL low	1.44			ms
Timeout, low	$T_{imeout,L}$	SCL low	27		33	ms
Timeout, high	$T_{imeout,H}$	SCL high	45		55	$\mu s$
Acknowledge setup time	$T_{suac}(MD)$	8-th SCL falling edge, Master			1.5	$\mu s$
Acknowledge hold time	$T_{hdac}(MD)$	9-th SCL falling edge, Master			1.5	$\mu s$
Acknowledge setup time	$T_{suac}(SD)$	8-th SCL falling edge, Slave			2.5	$\mu s$
Acknowledge hold time	$T_{hdac}(SD)$	9-th SCL falling edge, Slave			1.5	$\mu s$
<b>EEPROM</b>						
Data retention		$Ta = +85^{\circ}C$	10			years
Erase/write cycles		$Ta = +25^{\circ}C$	100,000			Times
Erase/write cycles		$Ta = +125^{\circ}C$	10,000			Times
Erase cell time	$T_{erase}$			5		ms
Write cell time	$T_{write}$			5		ms

Table 4: Electrical specification MLX90614Bxx, Dxx

Note: refer to MLX90614Axx notes.

**SKY** **TECH**  
ELECTRONIC

## 8. Detailed description

### 8.1. Block diagram

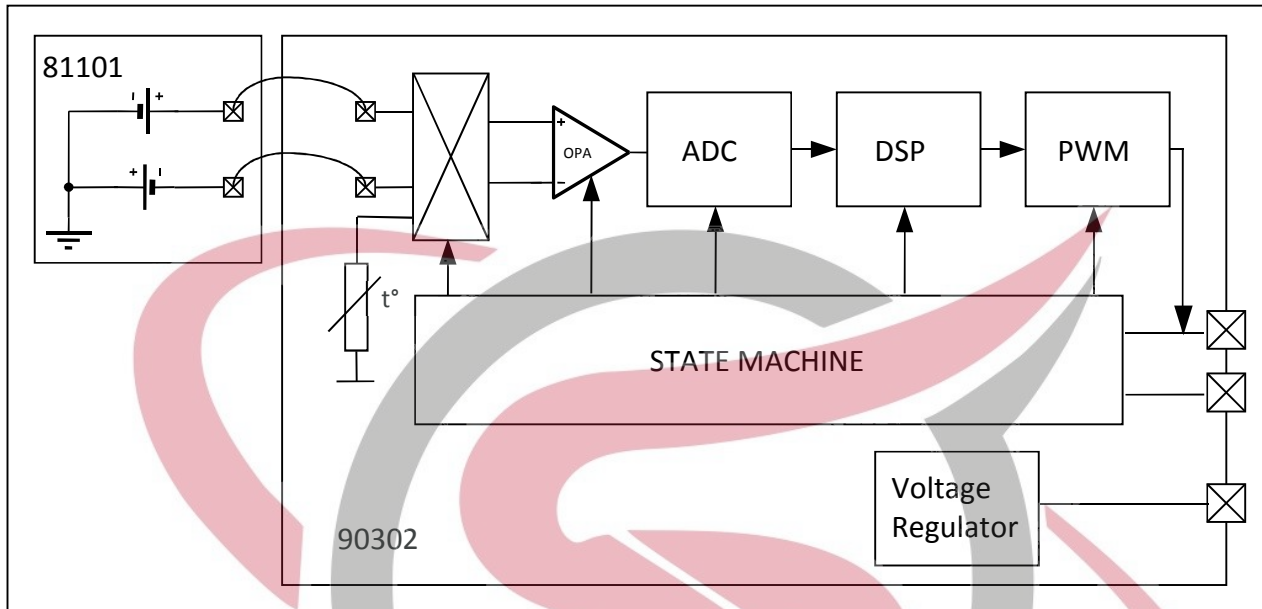

Figure 3: Block diagram

### 8.2. Signal processing principle

The operation of the MLX90614 is controlled by an internal state machine, which controls the measurements and calculations of the object and ambient temperatures and does the post-processing of the temperatures to output them through the PWM output or the SMBus compatible interface.

The ASSP supports 2 IR sensors (second one not implemented in the MLX90614xAx). The output of the IR sensors is amplified by a low noise low offset chopper amplifier with programmable gain, converted by a Sigma Delta modulator to a single bit stream and fed to a powerful DSP for further processing. The signal is treated by programmable (by means of EEPROM content) FIR and IIR low pass filters for further reduction of the band width of the input signal to achieve the desired noise performance and refresh rate. The output of the IIR filter is the measurement result and is available in the internal RAM. 3 different cells are available: One for the on-board temperature sensor and 2 for the IR sensors.

Based on results of the above measurements, the corresponding ambient temperature  $T_a$  and object temperatures  $T_o$  are calculated. Both calculated temperatures have a resolution of  $0.01^\circ\text{C}$ . The data for  $T_a$  and  $T_o$  can be read in two ways: Reading RAM cells dedicated for this purpose via the 2-wire interface ( $0.02^\circ\text{C}$  resolution, fixed ranges), or through the PWM digital output (10 bit resolution, configurable range).

In the last step of the measurement cycle, the measured  $T_a$  and  $T_o$  are rescaled to the desired output resolution of the PWM) and the recalculated data is loaded in the registers of the PWM state machine, which creates a constant frequency with a duty cycle representing the measured data.



## 8.3. Block description

### 8.3.1. Amplifier

A low noise, low offset amplifier with programmable gain is used for amplifying the IR sensor voltage. By carefully designing the input modulator and balanced input impedance, the max offset of the system is 0.5 $\mu$ V.

### 8.3.2. Supply regulator and POR

The module can operate from 3 different supplies:

VDD = 5V  $\rightarrow$  MLX90614Axx

VDD = 3V  $\rightarrow$  MLX90614Bxx (battery or regulated supply)

VDD = 8V...16V  $\rightarrow$  MLX90614Axx few external components are necessary please refer to “Applications information” section for information about adopting higher voltage supplies.

The Power On Reset (POR) is connected to Vdd supply. The on-chip POR circuit provides an active (high) level of the POR signal when the Vdd voltage rises above approximately 0.5V and holds the entire MLX90614 in reset until the Vdd is higher than the specified POR threshold  $V_{POR}$ . During the time POR is active, the POR signal is available as an open drain at the PWM/SDA pin. After the MLX90614 exits the POR condition, the function programmed in EEPROM takes precedence for that pin.

### 8.3.3. EEPROM

A limited number of addresses in the EEPROM memory can be changed by the customer. The whole EEPROM can be read through the SMBus interface.

EEPROM (32X16)		
Name	Address	Write access
To <sub>max</sub>	0x00	Yes
To <sub>min</sub>	0x01	Yes
PWMCTRL	0x02	Yes
Ta range	0x03	Yes
Emissivity	0x04	Yes
Config Register1	0x05	Yes
Melexis reserved	0x06	No
...	...	...
Melexis reserved	0x0D	No
SMBus address (LSByte only)	0x0E	Yes
Melexis reserved	0x0F	Yes
Melexis reserved	0x10	No
...	...	...
Melexis reserved	0x18	No
Melexis reserved	0x19	Yes
Melexis reserved	0x1A	No
Melexis reserved	0x1B	No
ID number	0x1C	No
ID number	0x1D	No
ID number	0x1E	No
ID number	0x1F	No

Table 5: EEPROM table

The addresses To<sub>max</sub>, To<sub>min</sub> and Ta range are for customer dependent object and ambient temperature ranges. For details see section 8.5.3 below in this document

The address **Emissivity** contains the object emissivity (factory default 1.0 = 0xFFFF), 16 bit.

$$\text{Emissivity} = \text{dec2hex}[\text{round}(65535 \times \epsilon)]$$

Where dec2hex[ round( X ) ] represents decimal to hexadecimal conversion with round-off to nearest value (not truncation).

In this case the physical emissivity values are  $\epsilon = 0.1...1.0$ .

Erase (write 0) must take place before write of desired data is made.

PWM period configuration: Period in extended PWM mode is twice the period in single PWM mode. In single PWM mode period is  $T = 1.024 * P$  [ms], where P is the number, written in bits 15...9 PWMCTRL. Maximum period is then 131.072 ms for single and 262.144 ms for extended. These values are typical and depend on the on-chip RC oscillator absolute value. The duty cycle must be calculated instead of working only with the high time only in order to avoid errors from the period absolute value deviations.

The address **PWMCTRL** consists of control bits for configuring the PWM/SDA pin as follows:

15	14	13	12	11	10	9	8	7	6	5	4	3	2	1	0	PWM control bit meaning
																0 - PWM extended mode
																1 - PWM single mode
																0 - PWM mode disabled (EN_PWM)
																1 - PWM mode enabled (EN_PWM)
																0 - SDA pin configured as Open Drain (PPODB)
																1 - SDA pin configured as Push-Pull (PPODB)
																0 - PWM mode selected (TRPWMB)
																1 - Thermal relay mode selected (TRPWMB)
																- PWM repetition number 0...62 step 2
																- PWM period 1.024*ms (Single PWM mode) or 2.048*ms (Extended PWM mode) multiplied by the number written in this place (128 in case the number is 0)

Table 6: PWM control bits

\* Values are valid for nominal HFO frequency

The address **ConfigRegister1** consists of control bits for configuring the analog and digital parts:

15	14	13	12	11	10	9	8	7	6	5	4	3	2	1	0	Config register bit meaning
																1 0 0 - IIR (100%) a1=1, b1=0
																1 0 1 - IIR (80%) a1=0.8, b1=0.2
																1 1 0 - IIR (67%) a1=0.666, b1=0.333
																1 1 1 - IIR (57%) a1=0.571, b1=0.428
																0 0 0 - IIR (50%) a1=0.5, b1=0.5
																0 0 1 - IIR (25%) a1=0.25, b1=0.75
																0 1 0 - IIR (17%) a1=0.166(6), b1=0.83(3)
																0 1 1 - IIR (13%) a1=0.125, b1=0.875
																0 - Repeat sensor test "OFF"
																1 - Repeat sensor test "ON"
																0 0 - Ta, Tobj1
																0 1 - Ta, Tobj2
																1 0 - Tobj2
																1 1 - Tobj1, Tobj2
																0 - Single IR sensor
																1 - Dual IR sensor
																0 - Positive sign of Ks
																1 - Negative sign of Ks
																0 0 0 - FIR = 8 - not recommended
																0 0 1 - FIR = 16 not recommended
																0 1 0 - FIR = 32 not recommended
																0 1 1 - FIR = 64 not recommended
																1 0 0 - FIR = 128
																1 0 1 - FIR = 256
																1 1 0 - FIR = 512
																1 1 1 - FIR = 1024
																0 0 0 - GAIN = 1 - Amplifier is bypassed
																0 0 1 - GAIN = 3
																0 1 0 - GAIN = 6
																0 1 1 - GAIN = 12,5
																1 0 0 - GAIN = 25
																1 0 1 - GAIN = 50
																1 1 0 - GAIN = 100
																1 1 1 - GAIN = 100
																0 - Positive sign of Kt2
																1 - Negative sign of Kt2
																0 - Enable sensor test
																1 - Disable sensor test

Table 7: Configuration register 1

Note: The following bits / registers should not be altered (except with special tools – contact Melexis for such tools availability) in order to keep the factory calibration relevant:

Emissivity [15...0]; Config Register1 [14...11;7;3]; addresses 0x0F and 0x19.

Check [www.melexis.com](http://www.melexis.com) for latest application notes with details on EEPROM settings.

**On-chip filtering and settling time:**

The MLX90614 features configurable on-chip digital filters. They allow customization for speed or noise. Factory default configurations and the typical settling time and noise for the MLX90614 family are given below.

Device	Settling time, sec	Typical noise, °C rms	Spike limit
MLX90614AAA, BAA, DAA	0.10	0.05	100%
MLX90614ABA, BBA	0.14	0.07	100%
MLX90614ACC, BCC, DCC	0.14	0.18	100%
MLX90614ACF, BCF	1.33	0.10	50%
MLX90614DCH, DCI, BCH, BCI	0.65	0.10	80%
MLX90614ACK, BCK	3.23	0.30	25%

*Table 8: factory default IIR and FIR configuration, settling time and typical noise*

Details on the filters are given in the application note “Understanding MLX90614 on-chip digital signal filters” available from [www.melexis.com](http://www.melexis.com).

The evaluation board, EVB90614 supported by PC SW allows easy configuration of the filters, while not requiring in-depth understanding of the EEPROM.

The available filter settings and the settling times are listed below. Settling time depends on three configurations: single / dual zone, IIR filter settings and FIR filter settings. The FIR filter has a straight forward effect on noise (4 times decreasing of filter strength increases the noise 2 times and vice versa). The IIR filter provides an additional, spike limiting feature. Spike limit defines the level of magnitude to which the spike would be limited – for example, 25% denotes that if a 20°C temperature delta spike is measured the temperature reading by the MLX90614 will spike only 5°C.

IIR setting	FIR setting	Settling time (s)		Spike limit
		90614xAx	90614xBx, 90614xCx	
xxx	000...011	Not recommended		
100	100	0.04	0.06	100.00%
100	101	0.05	0.07	100.00%
100	110	0.06	0.10	100.00%
100	111	0.10	0.14	100.00%
101	100	0.12	0.20	80.00%
101	101	0.16	0.24	80.00%
101	110	0.22	0.34	80.00%
101	111	0.35	0.54	80.00%
110	100	0.24	0.38	66.70%
110	101	0.30	0.48	66.70%
110	110	0.43	0.67	66.70%
110	111	0.70	1.10	66.70%
111	100	0.26	0.42	57.00%
111	101	0.34	0.53	57.00%
111	110	0.48	0.75	57.00%
111	111	0.78	1.20	57.00%
000	100	0.30	0.47	50.00%
000	101	0.37	0.60	50.00%
000	110	0.54	0.84	50.00%
000	111	0.86	1.33	50.00%
001	100	0.70	1.10	25.00%
001	101	0.88	1.40	25.00%
001	110	1.30	2.00	25.00%
001	111	2.00	3.20	25.00%
010	100	1.10	1.80	16.70%
010	101	1.40	2.20	16.70%
010	110	2.00	3.20	16.70%
010	111	3.30	5.00	16.70%
011	100	1.50	2.40	12.50%
011	101	1.90	3.00	12.50%
011	110	2.80	4.30	12.50%
011	111	4.50	7.00	12.50%

*Table 9: possible IIR and FIR settings*

Note: Settling time is in seconds and depends on internal oscillator absolute value.  
 100% spike limit appears with the IIR filter bypassed, and there is no spike limitation.

### 8.3.3.1. EEPROM write sequence

When EEPROM cell content is to be changed Melexis recommends following procedure:

1. Power up the device
2. Write 0x0000 into the cell of interest (effectively erasing the cell)
3. Wait at least 5ms (10ms to be on the safe side)
4. Write the new value
5. Wait at least 5ms (10ms to be on the safe side)
6. Read back and compare if the write was successful
7. Power down (to be sure that when power up next time the changes will take place)

### 8.3.4. RAM

It is not possible to write into the RAM memory. It can only be read and only a limited number of RAM registers are of interest to the customer.

RAM (32x16)		
Name	Address	Read access
Melexis reserved	0x00	Yes
...	...	...
Melexis reserved	0x03	Yes
Raw data IR channel 1	0x04	
Raw data IR channel 2	0x05	
T <sub>A</sub>	0x06	Yes
T <sub>OBJ1</sub>	0x07	Yes
T <sub>OBJ2</sub>	0x08	Yes
Melexis reserved	0x09	Yes
...	...	...
Melexis reserved	0x1F	Yes

Table 10: Ram addresses

## 8.4. SMBus compatible 2-wire protocol

The chip supports a 2 wires serial protocol, build with pins PWM / SDA and SCL.

- SCL – digital input only, used as the clock for SMBus compatible communication. This pin has the auxiliary function for building an external voltage regulator. When the external voltage regulator is used, the 2-wire protocol is available only if the power supply regulator is overdriven.
- PWM/SDA – Digital input / output, used for both the PWM output of the measured object temperature(s) or the digital input / output for the SMBus. In PWM mode the pin can be programmed in EEPROM to operate as Push / Pull or open drain NMOS (open drain NMOS is factory default). In SMBus mode SDA is forced to open drain NMOS I/O, push-pull selection bit defines PWM / Thermal relay operation.

SMBus communication with MLX90614 is covered in details in application notes, available from [www.melexis.com](http://www.melexis.com).

### 8.4.1. Functional description

The SMBus interface is a 2-wire protocol, allowing communication between the Master Device (MD) and one or more Slave Devices (SD). In the system only one master can be presented at any given time [1]. The MLX90614 can only be used as a slave device.

Generally, the MD initiates the start of data transfer by selecting a SD through the Slave Address (SA). The MD has read access to the RAM and EEPROM and write access to 9 EEPROM cells (at addresses 0x00, 0x01, 0x02, 0x03, 0x04, 0x05\*, 0x0E, 0x0F, 0x19). If the access to the MLX90614 is a read operation it will respond with 16 data bits and 8 bit PEC only if its own slave address, programmed in internal EEPROM, is equal to the SA, sent by the master. The SA feature



## MLX90614 family

Single and Dual Zone  
Infra Red Thermometer in TO-39

allows connecting up to 127 devices (SA=0x00...0x07F) with only 2 wires, unless the system has some of the specific features described in paragraph 5.2 of reference [1]. In order to provide access to any device or to assign an address to a SD before it is connected to the bus system, the communication must start with zero SA followed by low R/W bit. When this command is sent from the MD, the MLX90614 will always respond and will ignore the internal chip code information.

**Special care must be taken not to put two MLX90614 devices with the same SA on the same bus as MLX90614 does not support ARP [1].**

The MD can force the MLX90614 into low consumption mode "sleep mode" (3V version only).

Read flags like "EEBUSY" (1 – EEPROM is busy with executing the previous write/erase), "EE\_DEAD" (1 – there is fatal EEPROM error and this chip is not functional\*\*).

*Note\*: This address is readable and writable. Bit 3 should not be altered as this will cancel the factory calibration.*

*Note\*\*: EEPROM error signaling is implemented in automotive grade parts only.*

### 8.4.2. Differences with the standard SMBus specification (reference [1])

There are eleven command protocols for standard SMBus interface. The MLX90614 supports only two of them. Not supported commands are:

- Quick Command
- Byte commands - Sent Byte, Receive Byte, Write Byte and Read Byte
- Process Call
- Block commands – Block Write and Write-Block Read Process Call

Supported commands are:

- Read Word
- Write Word

### 8.4.3. Detailed description

The PWM / SDA pin of MLX90614 can operate also as PWM output, depending on the EEPROM settings. If PWM is enabled, after POR the PWM / SDA pin is directly configured as PWM output. Even if the device is in PWM mode SMBus communication may be restored by a special command. That is why hereafter both modes are treated separately.

#### 8.4.3.1. Bus Protocol

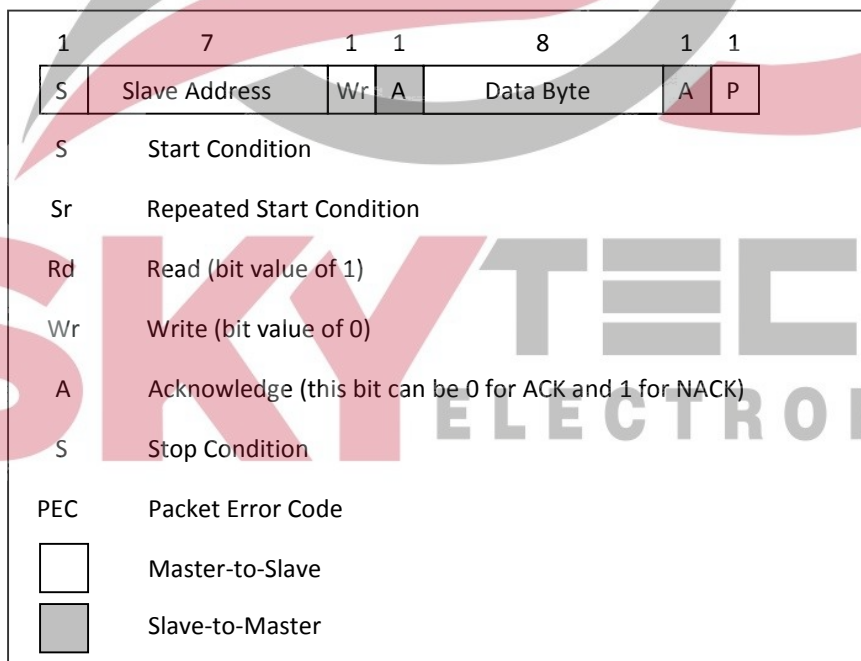

Figure 4: SMBus packet element key

After every received 8 bits the SD should issue ACK or NACK. When a MD initiates communication, it first sends the address of the slave and only the SD which recognizes the address will ACK, the rest will remain silent. In case the SD NACKs one of the bytes, the MD should stop the communication and repeat the message. A NACK could be received after the PEC. This



means that there is an error in the received message and the MD should try sending the message again. The PEC calculation includes all bits except the START, REPEATED START, STOP, ACK, and NACK bits. The PEC is a CRC-8 with polynomial  $X^8+X^2+X+1$ . The Most Significant Bit of every byte is transferred first.

**8.4.3.1.1. Read Word (depending on the command – RAM or EEPROM)**

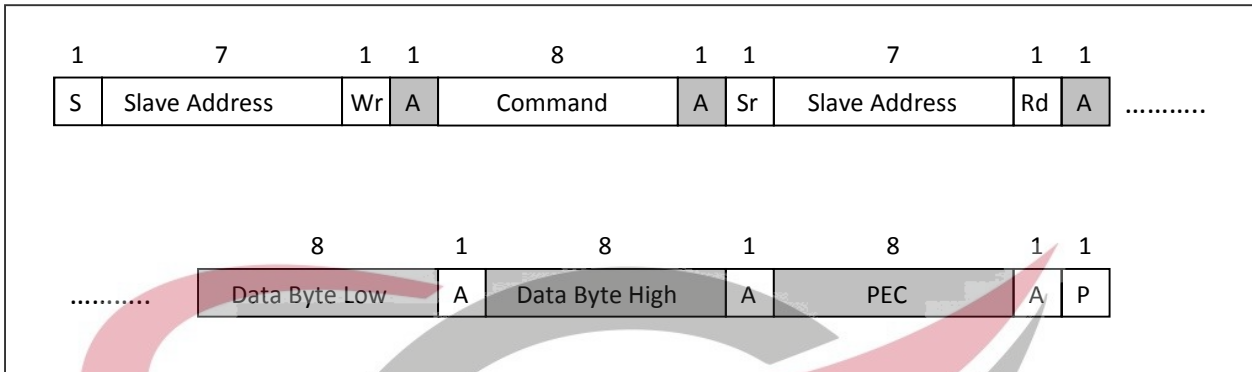

Figure 5: SMBus read word format

**8.4.3.1.2. Write Word (depending on the command – RAM or EEPROM)**

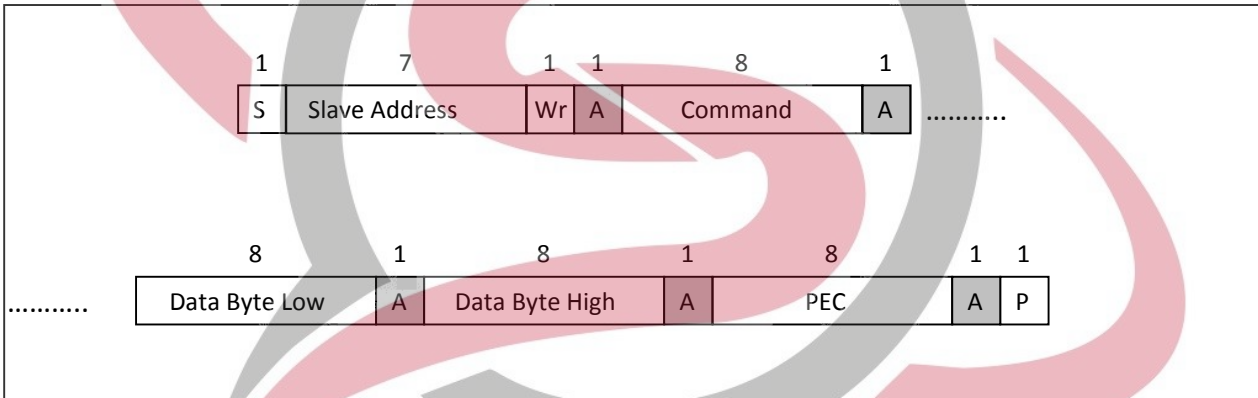

Figure 6: SMBus write word format

**8.4.4. Bit transfer**

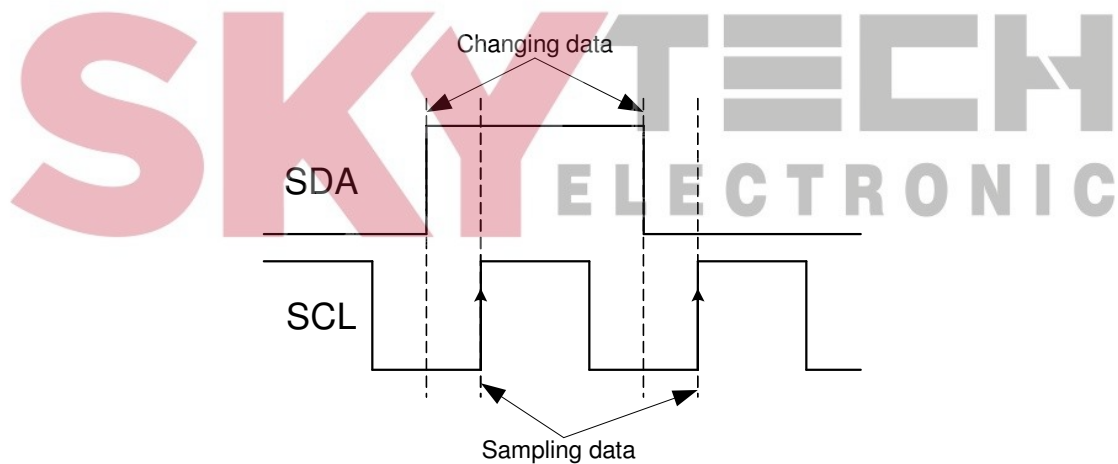

Figure 7: Recommended timing on SMBus

The data on PWM / SDA must be changed when SCL is low (min 300ns after the falling edge of SCL). The data is fetched by both MD and SDs on the rising edge of the SCL. The recommended timing for changing data is in the middle of the period when the SCL is low.

### 8.4.5. Commands

RAM and EEPROM can be read both with 32x16 sizes. If the RAM is read, the data are divided by two, due to a sign bit in RAM (for example, T<sub>01</sub> - RAM address 0x07 will sweep between 0x27AD to 0x7FFF as the object temperature changes from -70.01°C...+382.19°C). The MSB read from RAM is an error flag (active high) for the linearized temperatures (T<sub>01</sub>, T<sub>02</sub> and T<sub>a</sub>). The MSB for the raw data (e.g. IR sensor1 data) is a sign bit (sign and magnitude format). A write of 0x0000 must be done prior to writing in EEPROM in order to erase the EEPROM cell content. Refer to EEPROM detailed description for factory calibration EEPROM locations that need to be kept unaltered.

Opcode	Command
000x xxxx*	RAM Access
001x xxxx*	EEPROM Access
1111_0000**	Read Flags
1111_1111	Enter SLEEP mode

Table 11: SMBus commands

Note\*: The xxxx represent the 5 LSBits of the memory map address to be read / written.

Note\*\*: Behaves like read command. The MLX90614 returns PEC after 16 bits data of which only 4 are meaningful and if the MD wants it, it can stop the communication after the first byte. The difference between read and read flags is that the latter does not have a repeated start bit.

Flags read are:

- Data[7] - EEBUSY - the previous write/erase EEPROM access is still in progress. High active.
- Data[6] - Unused
- Data[5] - EE\_DEAD - EEPROM double error has occurred. High active.
- Data[4] - INIT - POR initialization routine is still ongoing. Low active.
- Data[3] - Not implemented.
- Data[2...0] and Data[8...15] - All zeros.

Flag read is a diagnostic feature. The MLX90614 can be used regardless of these flags.

For details and examples for SMBus communication with the MLX90614 check the [www.melexis.com](http://www.melexis.com)

### 8.4.6. SMBus communication examples

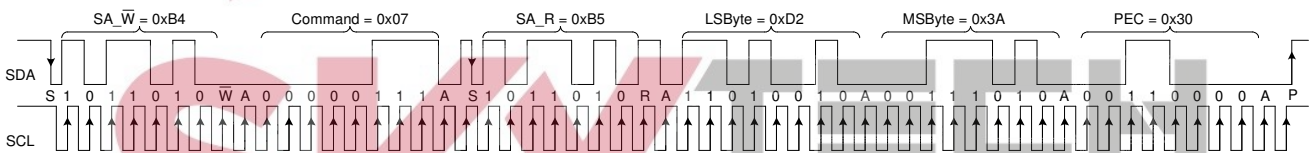

Figure 8: Read word format (SA=0x5A, read RAM=0x07, result=0x3AD2, PEC=0x30)

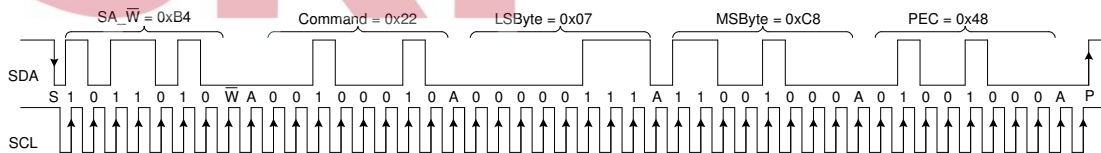

Figure 9: Write word format (SA=0x5A, write EEPROM=0x02, data=0xC807, PEC=0x48)

### 8.4.7. Timing specification

The MLX90614 meets all the timing specifications of the SMBus [1]. The maximum frequency of the MLX90614 SMBus is 100 KHz and the minimum is 10 KHz.

The specific timings in MLX90614's SMBus are:

SMBus Request ( $t_{REQ}$ ) is the time that the SCL should be forced low in order to switch MLX90614 from PWM mode to SMBus mode – at least 1.44ms;

Timeout L is the maximum allowed time for SCL to be low during communication. After this time the MLX90614 will reset its communication block and will be ready for new communication – not more than 27ms;

Timeout H is the maximum allowed time for SCL to be high during communication. After this time MLX90614 will reset its communication block assuming that the bus is idle (according to the SMBus specification) – not more than 45 $\mu$ s.

$T_{suac}(SD)$  is the time after the eighth falling edge of SCL that MLX90614 will force PWM / SDA low to acknowledge the last received byte – not more than 2.5 $\mu$ s.

$T_{hdac}(SD)$  is the time after the ninth falling edge of SCL that MLX90614 will release the PWM / SDA (so the MD can continue with the communication) – not more than 1.5 $\mu$ s.

$T_{suac}(MD)$  is the time after the eighth falling edge of SCL that MLX90614 will release PWM / SDA (so that the MD can acknowledge the last received byte) – not more than 1,5 $\mu$ s.

$T_{hdac}(MD)$  is the time after the ninth falling edge of SCL that MLX90614 will take control of the PWM / SDA (so it can continue with the next byte to transmit) – not more than 1.5 $\mu$ s.

The indexes MD and SD for the latest timings are used – MD when the master device is making acknowledge; SD when the slave device is making acknowledge. For other timings see [1].

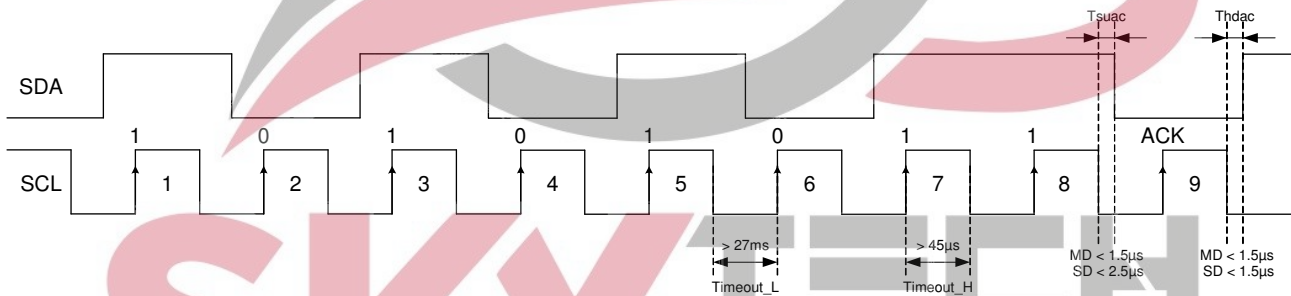

Figure 10: SMBus timing specification and definition

### 8.4.8. Sleep Mode

The MLX90614 can enter in Sleep Mode via the command “Enter SLEEP mode” sent via the SMBus interface. This mode is not available for the 5V supply version. There are two ways to put MLX90614 into power-up default mode:

- POR
- By Wake up request → SCL pin high and then PWM/SDA pin low for at least  $t_{DDQ} > 33ms$

If EEPROM is configured for PWM (EN\_PWM is high), the PWM interface will be selected after awakening and if PWM control [2], PPODB is 1 the MLX90614 will output a PWM pulse train with push-pull output.

NOTE: In order to limit the current consumption to the typical 2.5µA Melexis recommends that the SCL pin is kept low during sleep as there is leakage current through the internal synthesized zener diode connected to SCL pin. This may be achieved by configuring the MD driver of SCL pin as Push-Pull and not having Pull-Up resistor connected on SCL line.

#### 8.4.8.1. Enter Sleep Mode

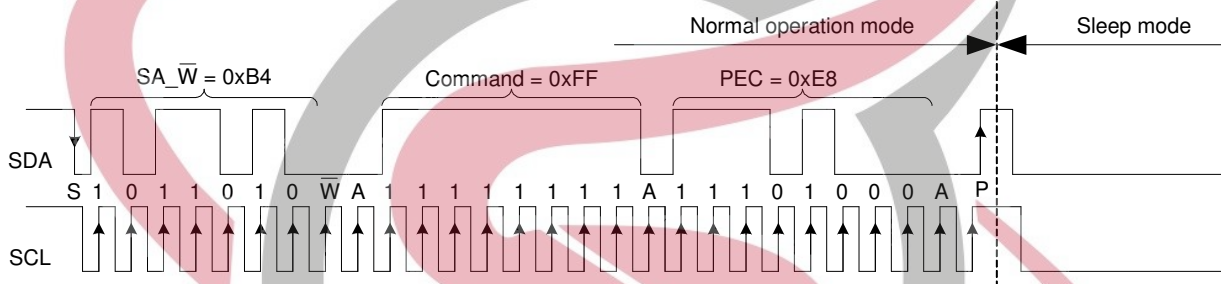

Figure 11: Enter sleep mode command (SA = 0x5A, Command = 0xFF, PEC = 0xE8)

#### 8.4.8.2. Exit from Sleep Mode (Wake up request)

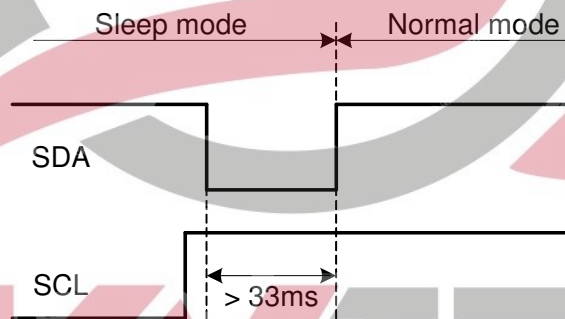
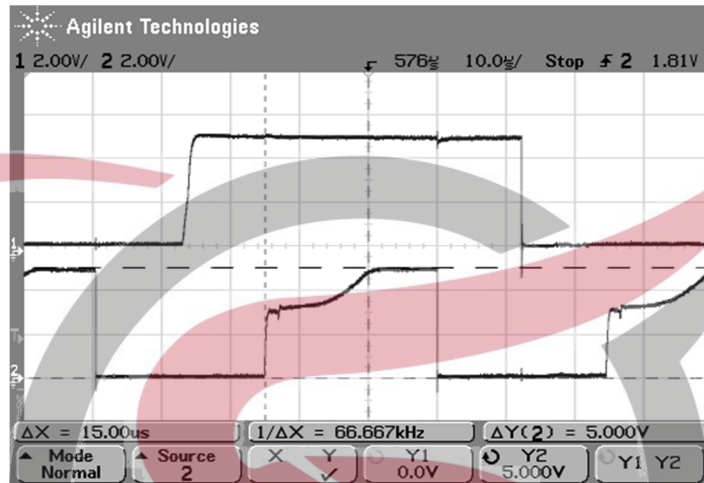

Figure 12: Exit Sleep Mode

After wake up the first data is available after 0.25 seconds (typ). On-chip IIR filter is skipped for the very first measurement. All measurements afterwards pass the embedded digital filtering as configured in EEPROM. Details on embedded filtering are available in application note “Understanding MLX90614 on-chip digital signal filters”, available from [www.melexis.com](http://www.melexis.com)

### 8.4.9. MLX90614 SMBus specific remarks

The auxiliary functions of the SCL pin (zener diode) add undershoot to the clock pulse (5V devices only) as shown in the picture below (see Figure 13). This undershoot is caused by the transient response of the on-chip synthesized Zener diode. Typical duration of undershoot is approximately 15 $\mu$ s. An increased reactance of the SCL line is likely to increase this effect. Undershoot does not affect the recognition of the SCL rising edge by the MLX90914, but may affect proper operation of non-MLX90614 slaves on the same bus.



*Figure 13: Undershoot of SCL line due to on chip synthesized Zener diode (5V versions only)*

Continuous SMBus readings can introduce an error. As the SCL line inside TO39 package is passing relatively close to the sensor input and error signal is induced to the sensor output. The manifestation of the problem is wrong temperature readings. This is especially valid for narrow FOV devices. Possible solution is to keep SDA and SCL line quiet for period longer than refresh rate and settling time defined by internal settings of MLX90614 prior reading the temperature or switch to PWM signal and completely disconnect from SDA and SCL line.





### 8.5. PWM

The MLX90614 can be read via PWM or SMBus compatible interface. Selection of PWM output is done in EEPROM configuration (factory default is SMBus). PWM output has two programmable formats, single and dual data transmission, providing single wire reading of two temperatures (dual zone object or object and ambient). The PWM period is derived from the on-chip oscillator and is programmable.

Config Register[5:4]	PWM1 data	PWM2 data	Tmin,1	Tmax,1	Tmin,2	Tmax,2
00	$T_A$	$T_{O1}$	$T_{A\_range,L}$	$T_{A\_range,H}$	$T_{O\_MIN}$	$T_{O\_MAX}$
01	$T_A$	$T_{O2}$	$T_{A\_range,L}$	$T_{A\_range,H}$	$T_{O\_MIN}$	$T_{O\_MAX}$
11	$T_{O1}$	$T_{O2}$	$T_{O\_MIN}$	$T_{O\_MAX}$	$T_{O\_MIN}$	$T_{O\_MAX}$
10*	$T_{O2}$	<b>Undefined</b>	$T_{O\_MIN}$	$T_{O\_MAX}$	<b>N.A.</b>	<b>N.A.</b>

Table 12: PWM configuration table

Note: Serial data functions (2-wire / PWM) are multiplexed with a thermal relay function (described in the “Thermal relay” section).

\* Not recommended for extended PWM format operation

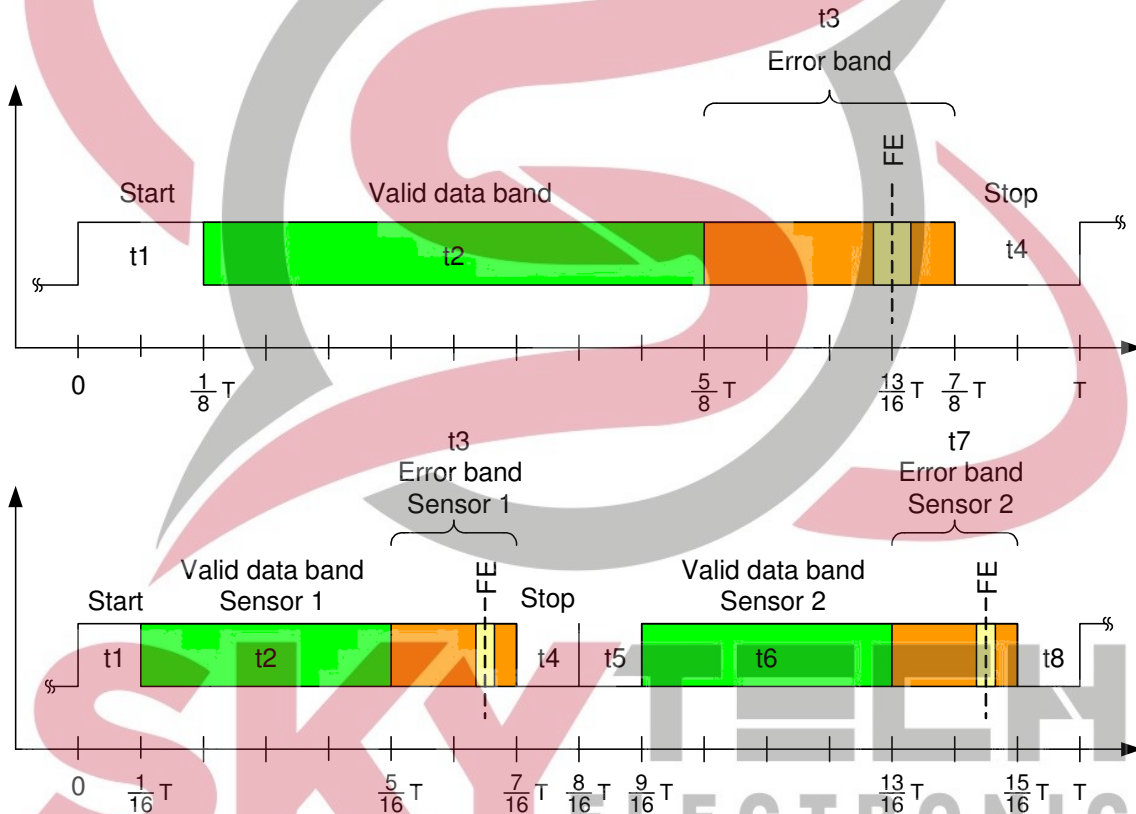

Figure 14: PWM timing single (above) and extended PWM (below)

PWM type	t1	t2	t3	t4	t5	t6	t7	t8
Single	1/8 – high	4/8 - var	2/8	1/8 – low	NA	NA	NA	NA
Extended - S1	1/16 - high	4/16 - var	2/16	1/16 - low	1/16 - low	4/16 – low	2/16 - low	1/16 - low
Extended - S2	1/16 - high	4/16 - high	2/16 - high	1/16 - high	1/16 - high	4/16 - var	2/16	1/16 - low

Table 13: PWM timing

### 8.5.1. Single PWM format

In single PWM output mode the settings for PWM1 data only are used. The temperature reading can be calculated from the signal timing as:

$$T_{OUT} = \left( \frac{2t_2}{T} \times (T_{O\_MAX} - T_{O\_MIN}) \right) + T_{O\_MIN}$$

where Tmin and Tmax are the corresponding rescale coefficients in EEPROM for the selected temperature output (Ta, object temperature range is valid for both Tobj1 and Tobj2 as specified in the previous table) and T is the PWM period. Tout is T<sub>O1</sub>, T<sub>O2</sub> or T<sub>a</sub> according to Config Register [5:4] settings.

The different time intervals t<sub>1</sub>...t<sub>4</sub> have following meaning:

t<sub>1</sub>: Start buffer. During this time the signal is always high. t<sub>1</sub> = 0.125s x T (where T is the PWM period, please refer to Figure 14).

t<sub>2</sub>: Valid Data Output Band, 0...1/2T. PWM output data resolution is 10 bit.

t<sub>3</sub>: Error band – information for fatal error in EEPROM (double error detected, not correctable).

t<sub>3</sub> = 0.25s x T. Therefore a PWM pulse train with a duty cycle of 0.875 will indicate a fatal error in EEPROM (for single PWM format). FE means Fatal Error.

Example:

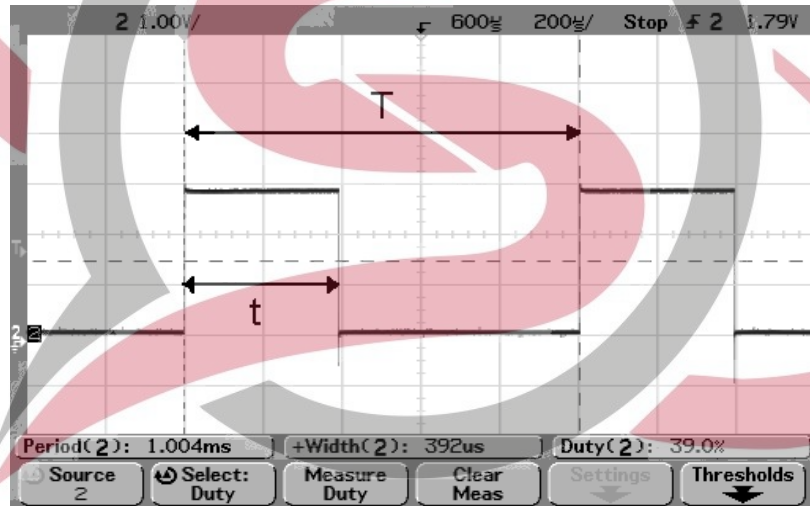

Figure 15: PWM example single mode

$$T_{O\_MIN} = 0^{\circ}C \rightarrow T_{O\_MIN} (EEPROM, 0x01) = 100 \times (T_{O\_MIN} + 273.15) = 27315d = 0x6AB3$$

$$T_{O\_MAX} = 50^{\circ}C \rightarrow T_{O\_MAX} (EEPROM, 0x00) = 100 \times (T_{O\_MAX} + 273.15) = 32315d = 0x7E3B$$

Captured PWM period is T = 1004μs

Captured high duration is t = 392 μs

Calculated duty cycle is:

$$D = \frac{t}{T} = \frac{392}{1004} = 0.3904 \text{ or } 39.04\%$$

The temperature is calculated as follows:

$$T_o = 2 \times (0.3904 - 0.125) \times (50 - 0) + 0 = 2 \times 0.2654 \times 50 = 26.54^{\circ}C$$

### 8.5.2. Extended PWM format

The PWM format for extended PWM is shown in Figure 16. Note that with bits DUAL[5:1]>0x00 each period will be outputted 2N+1 times, where N is the decimal value of the number written in DUAL[5:1] ( $DUAL[5:1] = PWM\ control\ \&\ clock\ [8:4]$ ), like shown on Figure 16.

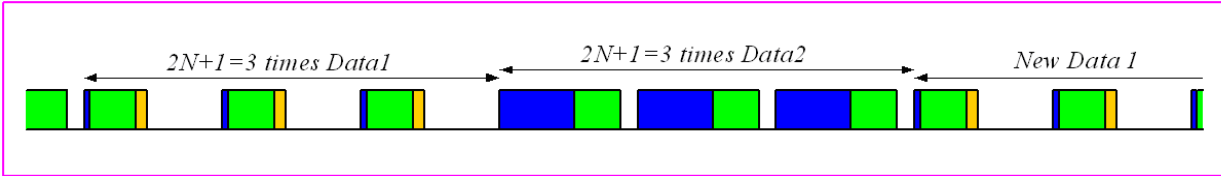

Figure 16: Extended PWM format with DUAL [5:1] = 01h (2 repetitions for each data)

The temperature transmitted in Data 1 field can be calculated using the following equation:

$$T_{OUT1} = \left( \frac{4t_2}{T} \times (T_{MAX1} - T_{MIN1}) \right) + T_{MIN1}$$

For Data 2 field the equation is:

$$T_{OUT2} = \left( \frac{4t_3}{T} \times (T_{MAX2} - T_{MIN2}) \right) + T_{MIN2}$$

Time bands are:  $t_1 = 0.0625 \times T$  (Start1),  $t_3 = 0.125 \times T$  and  $t_4 = 0.5625 \times T$  (Start2 = Start1 + Valida\_data1 + error\_band1 + stop1 + start2). As shown in Figure 13, in extended PWM format the period is twice the period for the single PWM format. All equations provided herein are given for the single PWM period T. The EEPROM Error band signaling will be 43.75% duty cycle for Data1 and 93.75% for Data2.

Note: EEPROM error signaling is implemented in automotive grade parts only.

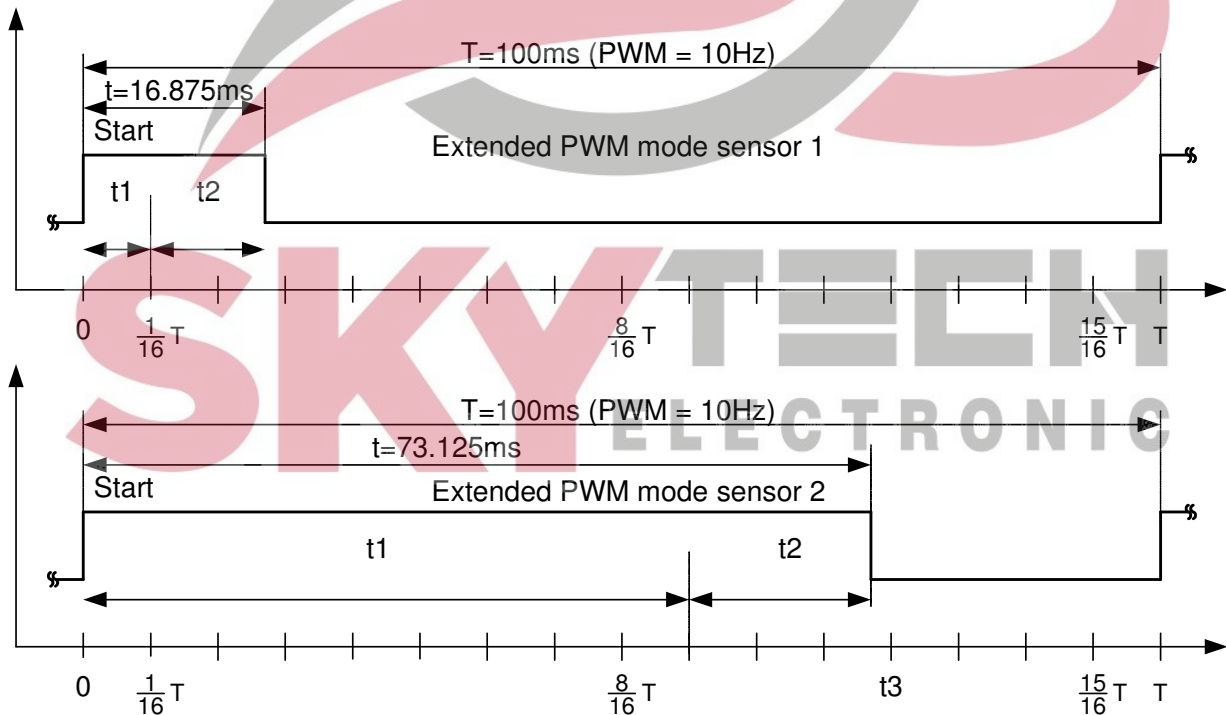

Figure 17: Example: Extended PWM mode readings – sensor 1 above and sensor 2 below

Example: (see Figure 17 above):

Configuration:

Sensor1 = Ta, Sensor2 = Tobj1 → Config Reg[5:4] = 00b,

$$T_{A\_MIN} = 0^{\circ}\text{C} \rightarrow T_{A\_RANGE\_L}(EEPROM) = 100 \times \frac{(T_{A\_min} + 38.2)}{64} = 59.6875 \approx 60d = 0x3C$$

$$T_{A\_MAX} = 60^{\circ}\text{C} \rightarrow T_{A\_RANGE\_H}(EEPROM) = 100 \times \frac{(T_{A\_max} + 38.2)}{64} = 153.4375 \approx 153d = 0x99$$

$$T_{A\_RANGE}(EEPROM, 0x03) = \{T_{A\_RANGE\_H} : T_{A\_RANGE\_L}\} = 0x993C$$

$$T_{O\_MIN} = 0^{\circ}\text{C} \rightarrow T_{O\_MIN}(EEPROM, 0x01) = 100 \times (T_{O\_min} + 273.15) = 27315d = 0x6AB3$$

$$T_{O\_MAX} = 50^{\circ}\text{C} \rightarrow T_{O\_MAX}(EEPROM, 0x00) = 100 \times (T_{O\_min} + 273.15) = 32315d = 0x7E3B$$

Captured high durations are:

$$\text{Sensor 1} - t = 16.875\text{ms at period } T = 100\text{ms thus the duty cycle is } Duty_{S1} = \frac{16.875}{100} = 0.16875$$

$$\text{Sensor 2} - t = 73.125\text{ms at period } T = 100\text{ms thus the duty cycle is } Duty_{S2} = \frac{73.125}{100} = 0.73125$$

The temperatures are calculated as follows:

$$T_A = 4 \times (Duty_{S1} - Start1) \times (T_{A\_MAX} - T_{A\_MIN}) + T_{A\_MIN}$$

$$T_A = 4 \times (0.16875 - 0.0625) \times (60 - 0) + 0 = 25.5^{\circ}\text{C}$$

$$T_{O1} = 4 \times (Duty_{S2} - Start2) \times (T_{O\_MAX} - T_{O\_MIN}) + T_{O\_MIN}$$

$$T_{O1} = 4 \times (0.73125 - 0.5625) \times (50 - 0) + 0 = 33.75^{\circ}\text{C}$$

### 8.5.3. Customizing the temperature range for PWM output

The calculated ambient and object temperatures are stored in RAM with a resolution of 0.01°C (16 bit). The PWM operates with a 10-bit word so the transmitted temperature is rescaled in order to fit in the desired range.

For this goal 2 cells in EEPROM are foreseen to store the desired range for To (To<sub>min</sub> and To<sub>max</sub>) and one for Ta (Ta<sub>range</sub>: the 8MSB are foreseen for Ta<sub>max</sub> and the 8LSB for Ta<sub>min</sub>).

Thus the output range for To can be programmed with an accuracy of 0.01°C, while the corresponding Ta range can be programmed with an accuracy of 0.64°C.

The object data for PWM is rescaled according to the following equation:

$$T_{PWM\_obj} = \frac{T_{RAM} - T_{MIN\_EEPROM}}{K_{PWM\_obj}}, K_{PWM\_obj} = \frac{T_{MAX\_EEPROM} - T_{MIN\_EEPROM}}{1023}$$

## MLX90614 family

Single and Dual Zone  
Infra Red Thermometer in TO-39

The  $T_{RAM}$  is the linearized  $T_{obj}$ , 16-bit (0x0000...0xFFFF, 0x0000 for -273.15°C and 0xFFFF for +382.2°C) and the result is a 10-bit word, in which 0x000 corresponds to  $T_{o_{MIN}}$ , °C, 0x3FF corresponds to  $T_{o_{MAX}}$ , °C and 1LSB corresponds to  $\frac{T_{o_{MAX}} - T_{o_{MIN}}}{1023}$ , °C.

$$T_{MIN_{EEPROM}} = T_{MIN} \times 100 \text{ LSB}$$

$$T_{MAX_{EEPROM}} = T_{MAX} \times 100 \text{ LSB}$$

The ambient data for PWM is rescaled according to the following equation:

$$T_{PWM_{ambient}} = \frac{T_{RAM} - T_{MIN_{EEPROM}}}{K_{PWM_{ambient}}}$$

Where:

$$K_{PWM_{ambient}} = \frac{T_{MAX_{EEPROM}} - T_{MIN_{EEPROM}}}{1023}$$

The result is a 10-bit word, where 0x000 corresponds to -38.2°C (lowest  $T_a$  that can be read via PWM), 0x3FF corresponds to 125°C (highest  $T_a$  that can be read via PWM) and 1LSB corresponds to:

$$1LSB = \frac{T_{MAX} - T_{MIN}}{1023}, [^{\circ}C]$$

$$T_{MIN_{EEPROM}} = (T_{MIN} - (-38.2)) \times \frac{100}{64} \text{ LSB}$$

$$T_{MAX_{EEPROM}} = (T_{MAX} - (-38.2)) \times \frac{100}{64} \text{ LSB}$$

**SKYTECH**  
ELECTRONIC



## 8.6. Switching Between PWM / Thermal relay and SMBus communication

### 8.6.1. PWM is enabled

The diagram below illustrates the way of switching to SMBus if PWM / Thermal Relay is enabled (factory programmed POR default for MLX90614 is SMBus, PWM disabled). Note that the SCL pin needs to be kept high in order to use PWM.

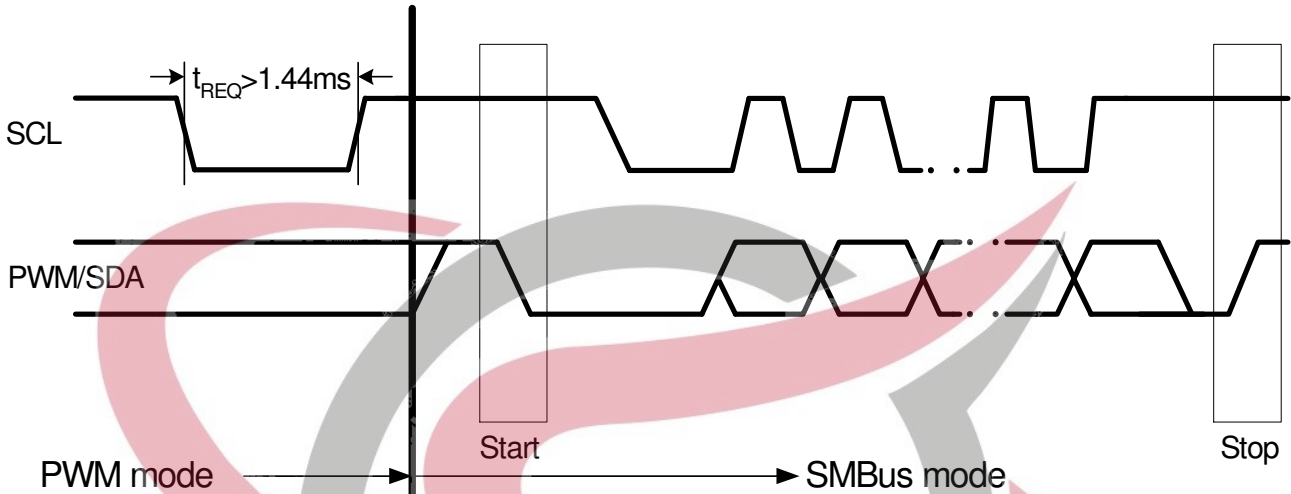

Figure 18: Switching from PWM mode to SMBus

### 8.6.2. Request condition

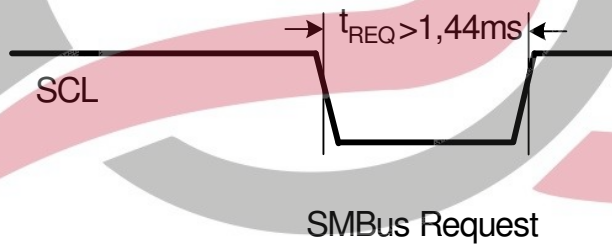

Figure 19: Request (switch to SMBus) condition

If PWM / Thermal relay is enabled, the MLX90614's SMBus Request condition is needed to disable PWM / Thermal relay and reconfigure PWM/SDA pin before starting SMBus communication. Once PWM / Thermal relay is disabled, it can be only enabled by switching the supply OFF – ON or exit from Sleep Mode. The MLX90614's SMBus request condition requires forcing LOW the SCL pin for period longer than the request time ( $t_{REQ} > 1.44ms$ ). The SDA line value is ignored and is irrelevant in this case.

### 8.6.3. PWM is disabled

If PWM is disabled by means of EEPROM the PWM / SDA pin is directly used for the SMBus after POR. **Request condition should not be sent in this case.**

## 8.7. Computation of ambient and object temperatures

The IR sensor consists of serial connected thermo-couples with cold junctions placed at thick chip substrate and hot junctions, placed over thin membrane. The IR radiation absorbed from the membrane heats (or cools) it. The thermopile output signal is:

$$V_{ir}(T_a, T_o) = A \times (T_o^4 - T_a^4)$$

Where  $T_o$  is the absolute object temperature (Kelvin),  $T_a$  is the sensor die absolute (Kelvin) temperature, and  $A$  is the overall sensitivity.

An on board temperature sensor is needed to measure the chip temperature. After measurement of the output of both sensors, the corresponding ambient and object temperatures can be calculated. These calculations are done by the internal DSP, which produces digital outputs, linearly proportional to measured temperatures.

### 8.7.1. Ambient temperature $T_a$

The Sensor die temperature is measured with a PTAT element. All the sensors conditioning and data processing is handled on-chip and the linearized sensor die temperature  $T_a$  is available in memory.

The resolution of the calculated temperature is 0.02°C. The sensor is factory calibrated for the full automotive range -40...+125°C. The linearized die temperature is available in RAM cell 0x06:

0x06=0x2DE4 (11748d) corresponds to -38.2°C (linearization output lower limit)  
0x06=0x4DC4 (19908d) corresponds to +125°C. (linearization output higher limit)

The conversions from RAM content to real  $T_a$  is easy using the following relation:

$$T_a[^\circ K] = T_{areg} \times 0.02, \text{ or } 0.02^\circ K / \text{LSB.}$$

### 8.7.2. Object temperature $T_o$

The result has a resolution of 0.02°C and is available in RAM.  $T_o$  is derived from RAM as:

$$T_o[^\circ K] = T_{oreg} \times 0.02, \text{ or } 0.02^\circ K / \text{LSB.}$$

Please note that 1LSB corresponds to 0.02°C and the MSB bit is error flag (if "1" then error).

Example:

1. 0x27AD → -70.00°C (no error)
2. 0x27AE → -69.98°C (no error)
3. 0x3AF7 → 28.75°C (no error)
4. 0x3AF8 → 28.77°C (no error)
5. 0x7FFF → 382.19°C (no error) - maximum possible value returned by MLX90614
6. 0x8XXX → xxx.xx°C (flag error)

The result is calculated by following expressions (valid for both  $T_o$  and  $T_a$ ):

1. Convert it to decimal value i.e. 0x3AF7 = 15095d

2. Divide by 50 (or multiply by 0.02) i.e.  $\frac{15095}{50} = 301.9$  K (result is in Kelvin)

3. Convert K → °C i.e. 301.9 - 273.15 = 28.75°C

### 8.7.3. Calculation flow

The measurement, calculation and linearization are held by core, which executes a program from ROM. After POR the chip is initialized with calibration data from EEPROM. During this phase the number of IR sensors is selected and it is decided which temperature sensor will be used. Measurements, compensation and linearization routines run in a closed loop afterwards.

#### Processing ambient temperature includes:

Offset measurement with fixed length FIR filter  
Additional filtering with fixed length IIR filter. The result is stored into RAM as  $T_{OS}$   
Temperature sensor measurement using programmable length FIR \*.  
Offset compensation  
Additional processing with programmable length IIR \*\*. The result is stored into RAM as  $T_D$ .  
Calculation of the ambient temperature. The result is stored into RAM address 0x06 as  $T_A$

#### Processing of the object temperature consists of three parts.

The first one is common for both IR sensors, the third part can be skipped if only one IR sensor is used.

##### *IR offset:*

Offset measurement with a fixed length FIR  
Additional filtering with a fixed length IIR. The result is stored into RAM as  $IR_{OS}$ .  
Gain measurement with fixed length FIR filter  
Offset compensation  
Additional gain filtering with fixed length IIR, storing the result into RAM as  $IR_G$ .  
Gain compensation calculation, the result is stored into RAM as  $K_G$

##### *Object temperature:*

##### *IR1 sensor:*

IR sensor measurement with programmable length FIR filter \*.  
Offset compensation  
Gain compensation  
Filtering with programmable length IIR filter\*\*, storing the result into RAM address 0x04 as  $IR1_D$ .  
Calculation of the object temperature. The result is available in RAM address 0x07 as  $T_{O1}$ .

##### *IR2 sensor:*

IR sensor measurement with programmable length FIR filter \*.  
Offset compensation  
Gain compensation  
Filtering with programmable length IIR filter\*\*, storing the result into RAM address 0x05 as  $IR2_D$ .  
Calculation of the object temperature. The result is available in RAM address 0x08 as  $T_{O2}$

#### PWM calculation:

Recalculate the data for PWM with 10 bit resolution  
Load data into PWM module

**Note\*:** The measurements with programmable filter length for FIR filter use the same EEPROM cells for N.

**Note\*\*:** The IIR filter with programmable filter length uses the same EEPROM cells for L.

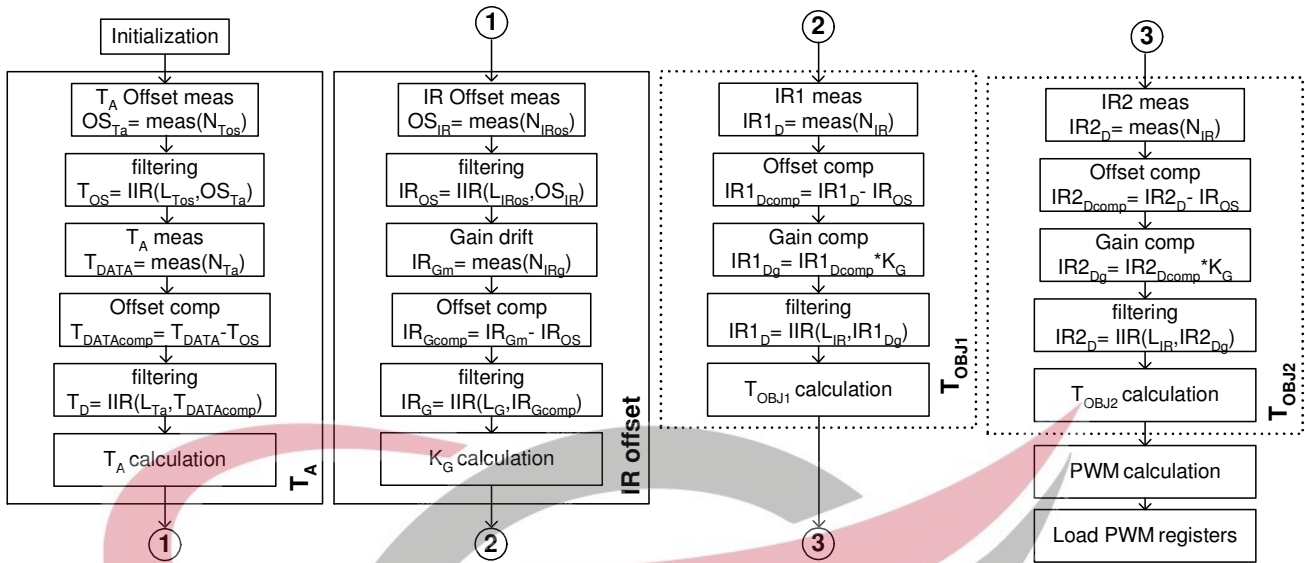

Figure 20: Software flow

## 8.8. Thermal relay

The MLX90614 can be configured as a thermo relay with programmable threshold and hysteresis on the PWM/SDA pin. The input for the comparator unit of the relay is the object temperature from sensor 1

**The output of the MLX90614 is NOT a relay driver but a logical output which should be connected to a relay driver if necessary.**

The output driver is one and the same for PWM and Thermal relay.

In order to configure the MLX90614 to work as thermal relay two conditions must be met:

- Set bit TRPWMB high at address 0x02 in EEPROM
- Enable PWM output i.e. EN\_PWM is set high

The PWM / SDA pin can be programmed as a push-pull or open drain NMOS (via bit PPODB in EEPROM PWMCTRL), which can trigger an external device. The temperature threshold data is determined by EEPROM at address 0x21 ( $T_{o_{min}}$ ) and the hysteresis at address 0x20 ( $T_{o_{max}}$ ).

The logical state of the PWM/SDA pin is as follows:

PWM / SDA pin is high if  $T_{o1} \geq \text{threshold} + \text{hysteresis}$

PWM / SDA pin is low if  $T_{o1} \leq \text{threshold} - \text{hysteresis}$

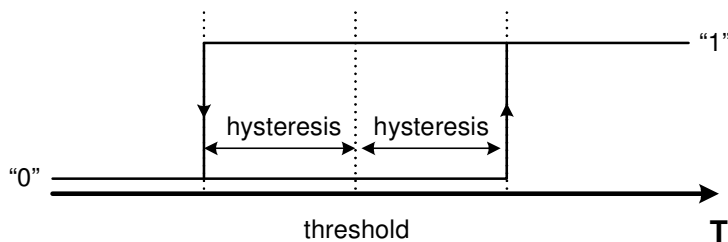

Figure 21: Thermal relay: "PWM" pin versus  $T_{obj}$

## MLX90614 family

Single and Dual Zone  
Infra Red Thermometer in TO-39

The MLX90614 preserves its normal operation when configured as a thermal relay (PWM configuration and specification applies as a general rule also for the thermal relay) and therefore it can be read using the SMBus (entering the SMBus mode from both PWM and thermal relay configuration is the same).

For example, the MLX90614 can generate a wake-up alert for a system upon reaching a certain temperature and then be read as a thermometer. Reset conditions (enter and exit Sleep, for example) will be needed in order to return to the thermal relay configuration.

Example:

$$\text{Threshold} = 5^{\circ}\text{C} \rightarrow (\text{EEPROM}, 0x01) = 100 \times (\text{Threshold} + 273.15) = 27815d = 0x6CA7$$

$$\text{Hysteresis} = 1^{\circ}\text{C} \rightarrow (\text{EEPROM}, 0x00) = 100 \times \text{Hysteresis} = 100d = 0x0064$$

Smallest possible hysteresis is 0,01°C or (EEPROM, 0x00 = 0x0001)

PWM / SDA pin will be set low at object temperature below 4°C

PWM / SDA pin will be set high at object temperature higher than 6°C

## 9. Unique Features

- The MLX90614 is a ready-to use low-cost non-contact thermometer provided from Melexis with output data linearly dependent on the object temperature with high accuracy and extended resolution.
- The high thermal stability of the MLX90614-xCx make this part highly suited in applications where secondary heat sources can heat up the sensor. These sensors also have a very short stabilization time compared to other types of thermopile sensors, which is of importance if one needs an accurate measurement in conditions where the ambient temperature can change quickly.
- The MLX90614 supports versatile customization to a very wide range of temperatures, power supplies and refresh rates.
- The user can program the internal object emissivity correction for objects with a low emissivity. An embedded error checking and correction mechanism provides high memory reliability.
- The sensors are housed in an industry standard TO39 package for both single- and dual-zone IR thermometers. The thermometer is available in automotive grade and can use two different packages for wider applications' coverage.
- The low power consumption during operation and the low current draw during sleep mode make the thermometer ideally suited for handheld mobile applications.
- The digital sensor interface can be either a power-up-and-measure PWM or an enhanced access SMBus compatible protocol. Systems with more than 100 devices can be built with only two signal lines. Dual zone non-contact temperature measurements are available via a single line (extended PWM).
- A build-in thermal relay function further extends the easy implementation of wide variety of freezing/boiling prevention and alert systems, as well as thermostats (no MCU is needed).



## 10. Performance Graphs

### 10.1. Temperature accuracy of the MLX90614

#### 10.1.1. Standard accuracy

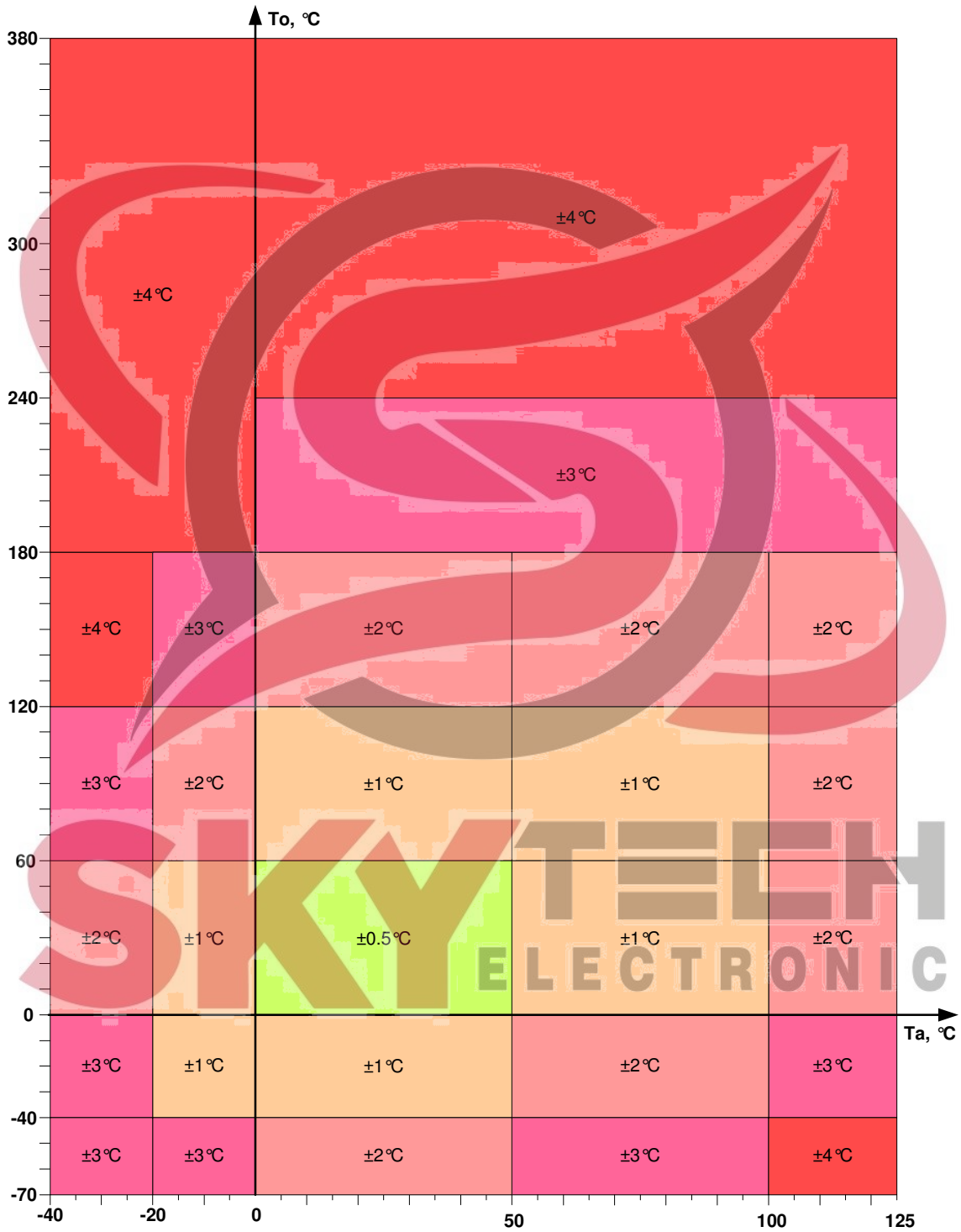

Figure 22: Accuracy of MLX90614 (Ta, To) except for xCK type

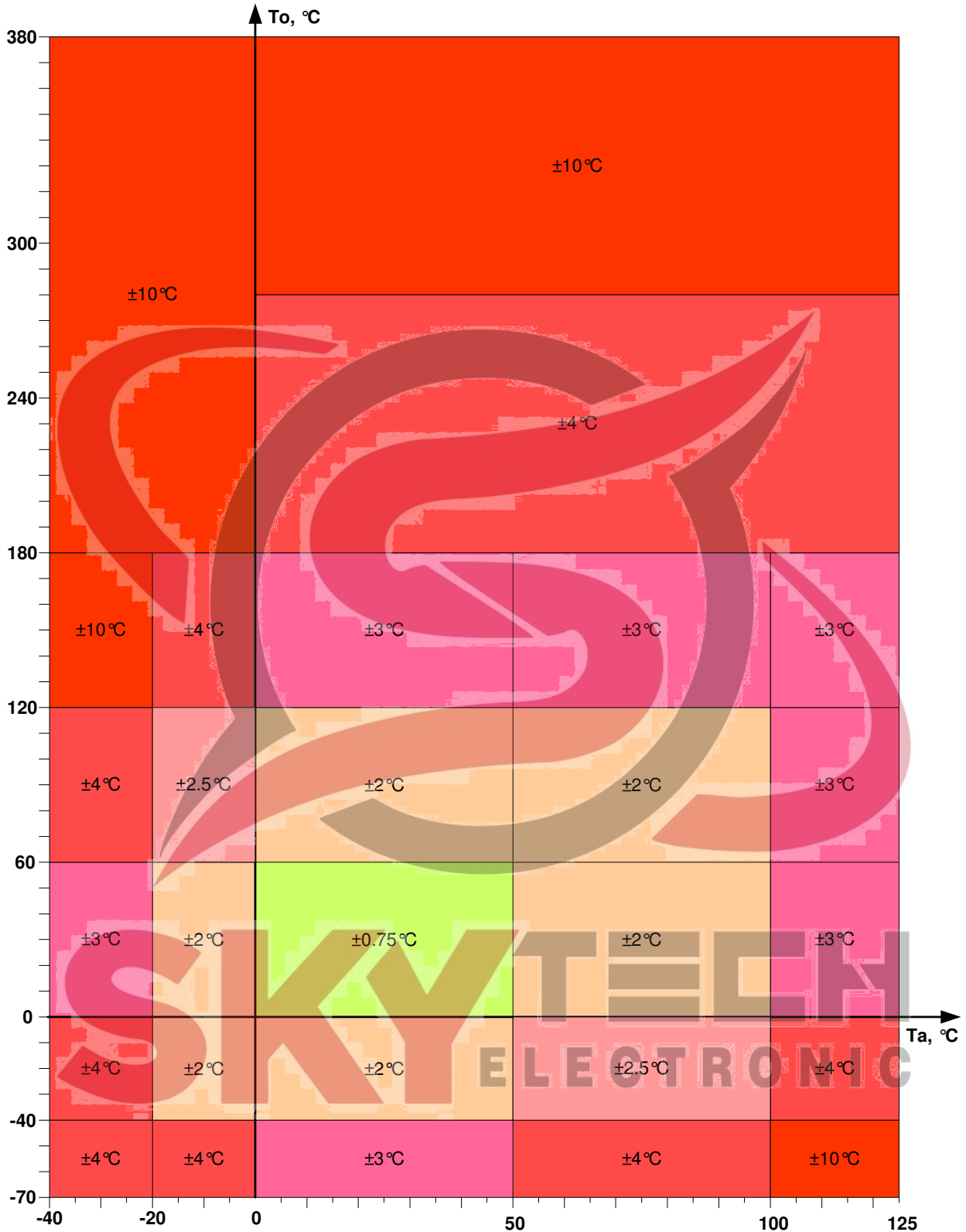

Figure 23 Accuracy of MLX90614xCK (Ta, To) only

All accuracy specifications apply under settled isothermal conditions only. Furthermore, the accuracy is only valid if the object fills the FOV of the sensor completely.

### 10.1.2. Medical accuracy

A version of the MLX90614 with accuracy suited for medical applications is available. The accuracy in the range  $T_a$  16°C...40°C and  $T_o$  22°C...40°C is shown in diagram below. The accuracy for the rest of the temperature ranges is the same as in previous diagram. Medical accuracy specification is only available for the MLX90614Dxx versions.

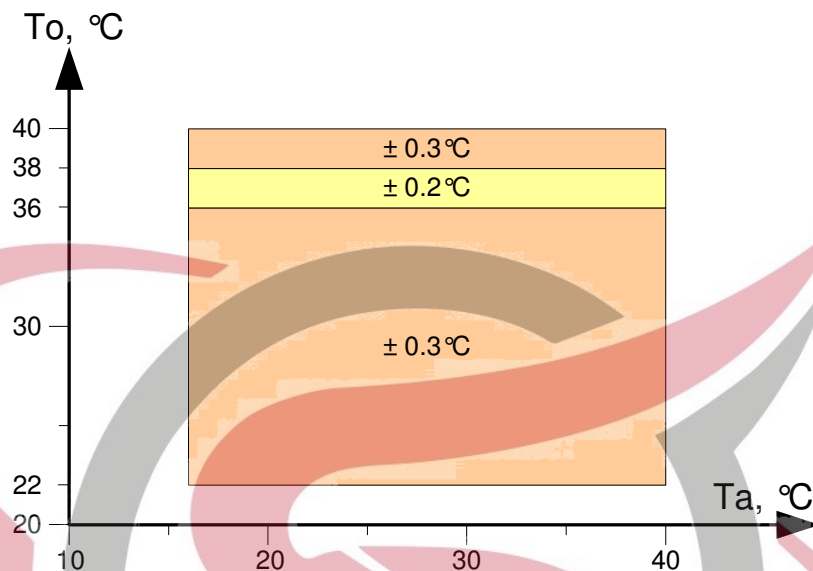

Figure 24: Accuracy of MLX90614DAA ( $T_a$ ,  $T_o$ ) for medical applications.  
 Accuracy of the MLX90614DCC, DCH and DCI for VDD = 3V (see paragraph 10.1.3)

Versions MLX90614ESF-DCC, -DCH and -DCI comply with ASTM standard section 5.4 (Designation: E1965 – 98 (Re-approved 2009) - Standard Specification for Infrared Thermometers for Intermittent Determination of Patient Temperature

It is very important for the application designer to understand that the accuracy specified in Figure 22 and Figure 24 are only guaranteed when the sensor is in thermal equilibrium and under isothermal conditions (there are no temperature differences across the sensor package). The accuracy of the thermometer can be influenced by temperature differences in the package induced by causes like (among others): Hot electronics (heaters / coolers) behind or beside the sensor or when the measured object is so close to the sensor that heats the thermometer package.

This effect is especially relevant for thermometers with a small Field Of View (FOV) like the xxC and xxF as the energy received by the sensor from the object is reduced. Therefore, Melexis has introduced the xCx version of the MLX90614. In these MLX90614xCx, the thermal gradients are measured internally and the measured temperature is compensated for them. In this way, the MLX90614xCx is much less sensitive to thermal gradients induced from outside, but the effect is not totally eliminated. It is therefore important to avoid introducing strong heat sources close to the sensor or to shield the sensor from them.

**NOTE:** In order to have the highest possible signal and the best performance a higher gain of the amplifier is selected for MLX90614DCx type of devices. This eventually would limit the maximum object temperature (due to overload of the ADC) to about 200°C.

### 10.1.3. Temperature reading dependence on VDD

In case of medical applications where high accuracy is required and the supply is provided by means of a battery, a compensation of temperature readings from VDD dependence should be done by the microcontroller. The dependence is very repeatable and compensation can easily be implemented. As this dependence comes from the ambient temperature it is the same for all type of devices regardless of FOV and optics used and it directly translates in the same compensation for object temperature.

The typical VDD dependence of the ambient and object temperature is 0.6°C/V.

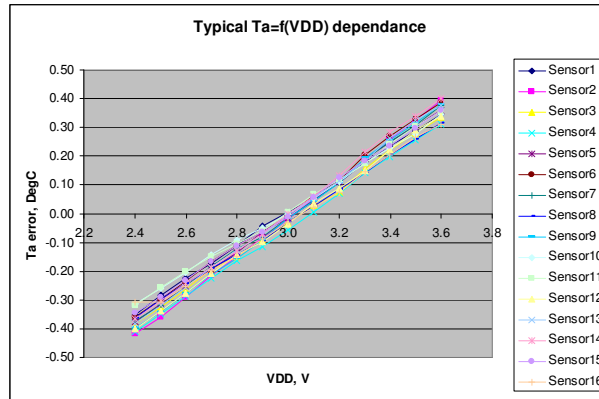

Figure 25: Typical  $T_a$  dependence from supply voltage

Example: As the devices are calibrated at VDD=3V the error at VDD=3V is smallest one. The error in ambient channel is directly transferred as object channel error (see Figure 26 below).

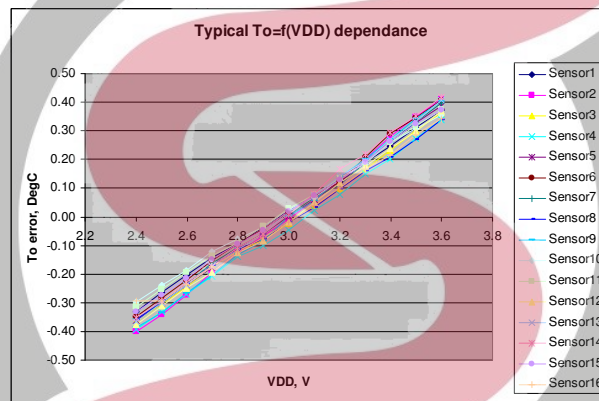

Figure 26: Typical  $T_o$  dependence from supply voltage (practically the same as  $T_a$  dependence error)

In order to compensate for this error we measure supply voltage and by applying following equation compensate the result.

$$T_{O\_compensated} = T_O - (VDD - VDD_0) \times Typical\_dependence = T_O - (VDD - 3) \times 0.6$$

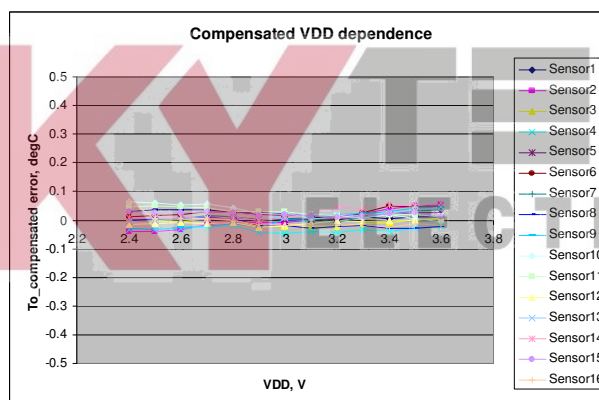

Figure 27: Typical  $T_o$  compensated dependence error

**10.2. Field Of View (FOV)**

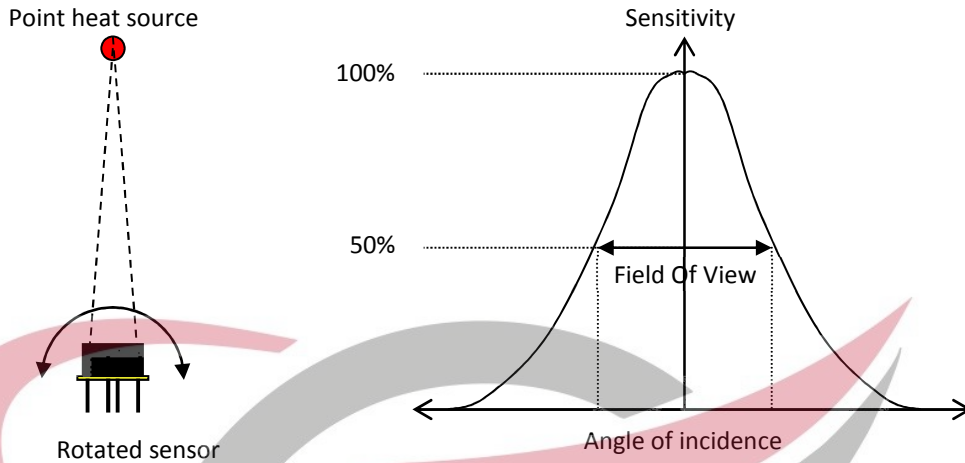

Figure 28: Field Of View measurement

Parameter	Type xAA	Type xBA	Type xCC	Type xCF	Type xCH	Type xCI	Type xCK
Peak zone 1	0°	+25°	0°	0°	0°	0°	0°
Width zone 1	90°	70°	35°	10°	12°	5°	13°
Peak zone 2	NA	-25°	NA	NA	NA	NA	NA
Width zone 2		70°					

Table 14: FOV summary table

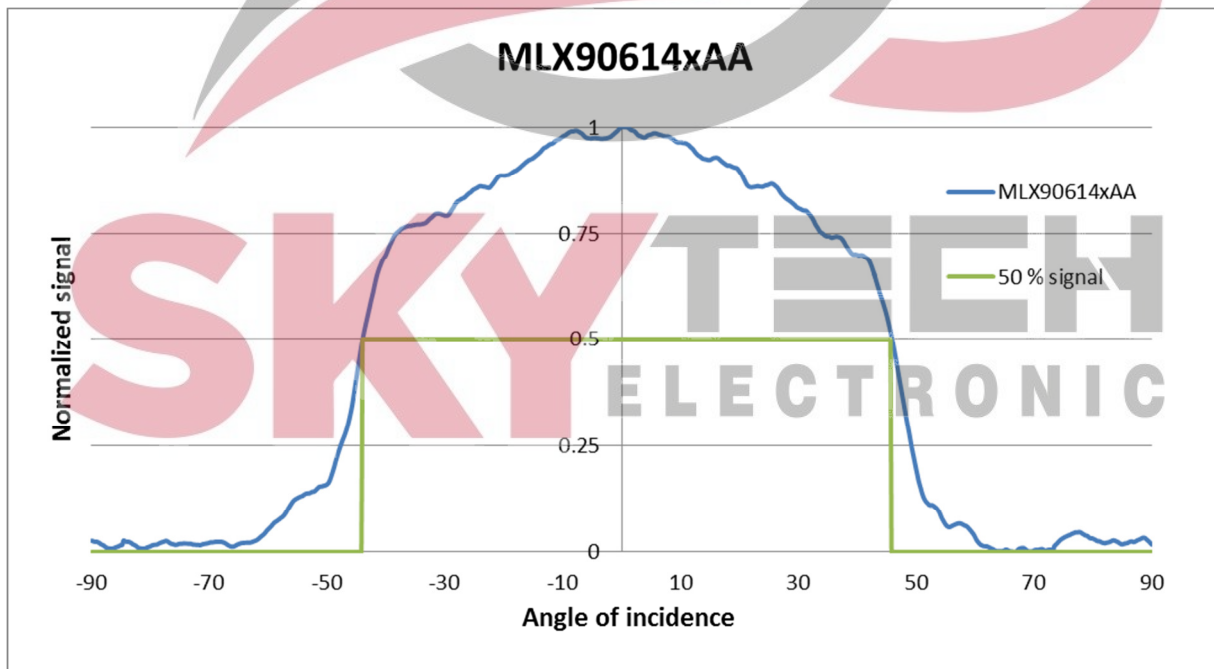

Figure 29: Typical FOV of MLX90614xAA



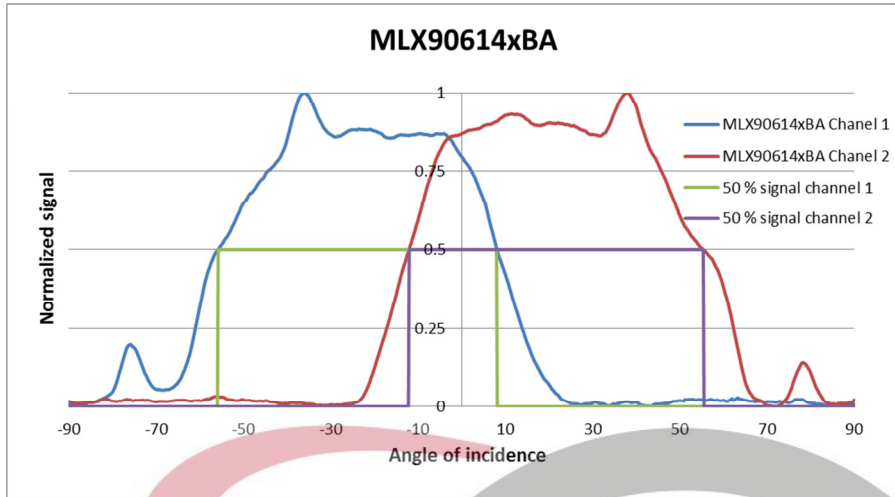

Figure 30: Typical FOV of MLX90614xBA

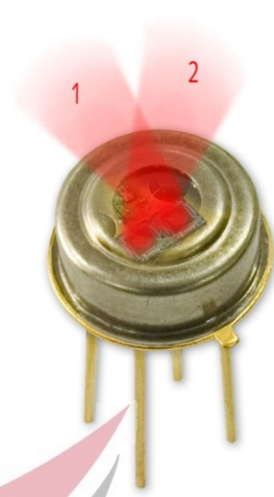

Figure 31: Identification of zone 1&2 relative to alignment tab

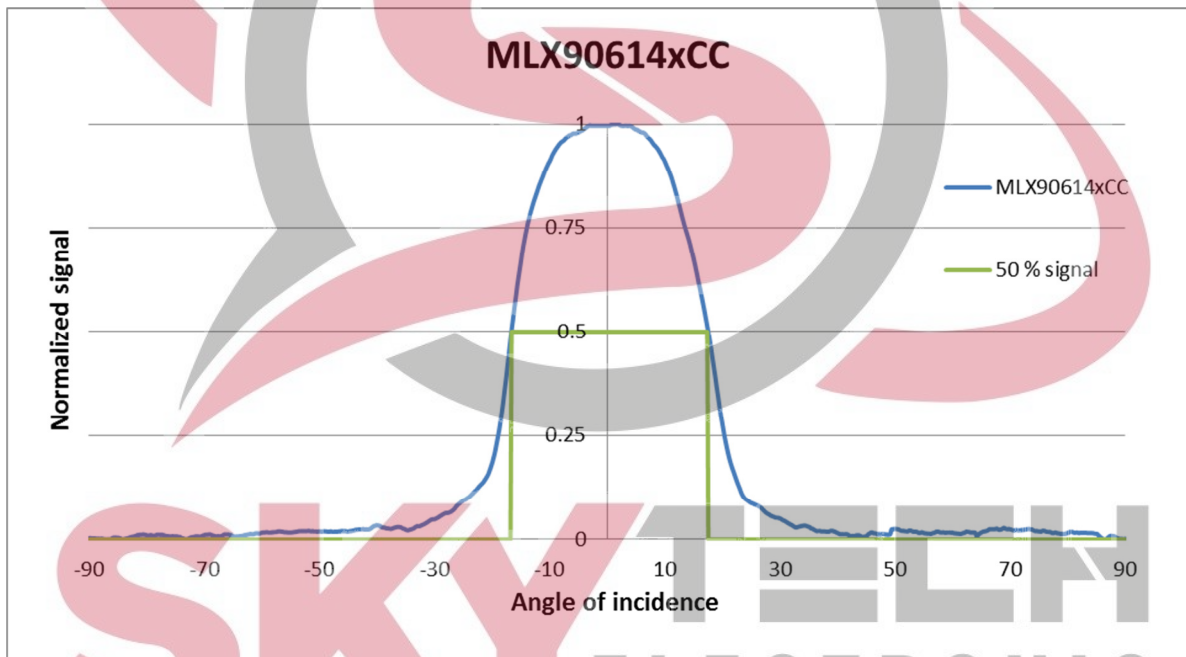

Figure 32: Typical FOV of MLX90614xCC

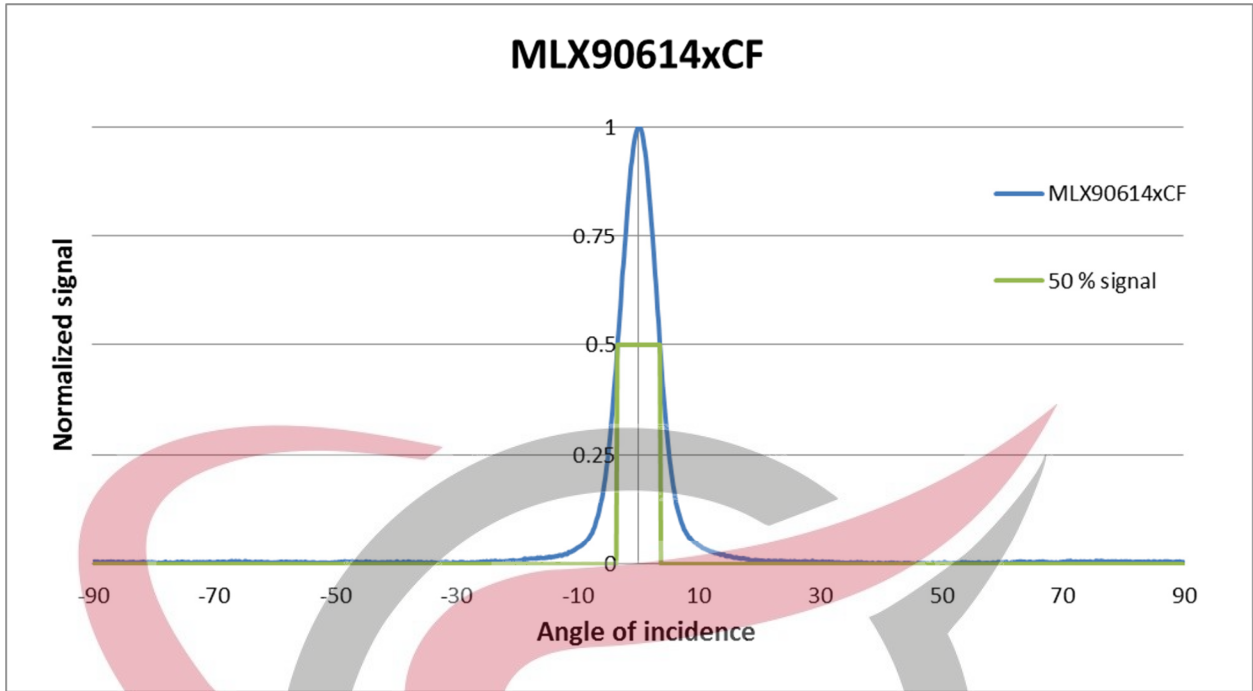

Figure 33: Typical FOV of MLX90614xCF

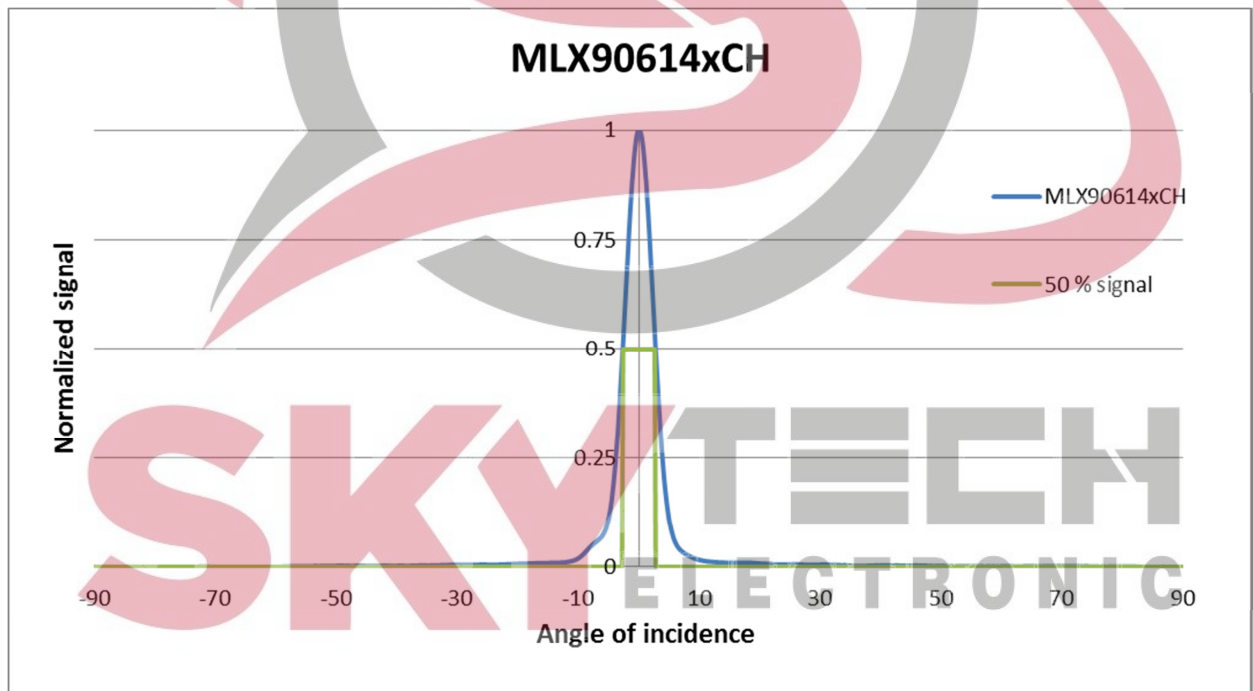

Figure 34: Typical FOV of MLX90614xCH

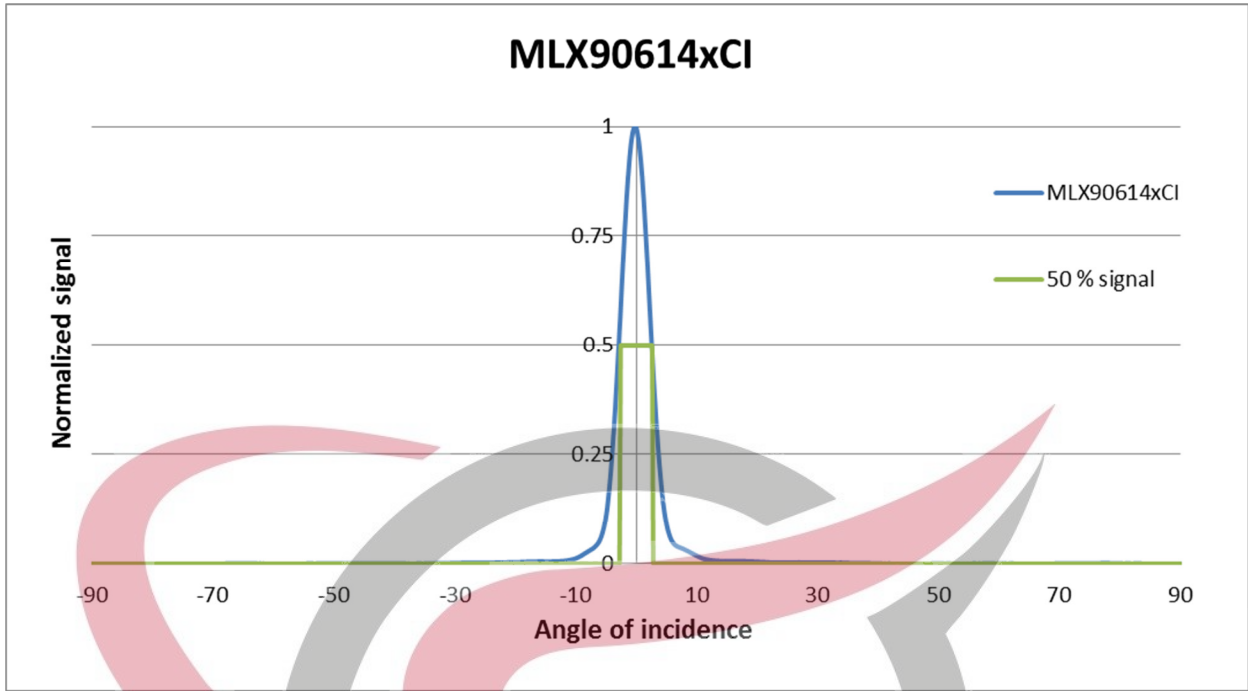

Figure 35: Typical FOV of MLX90614xCI

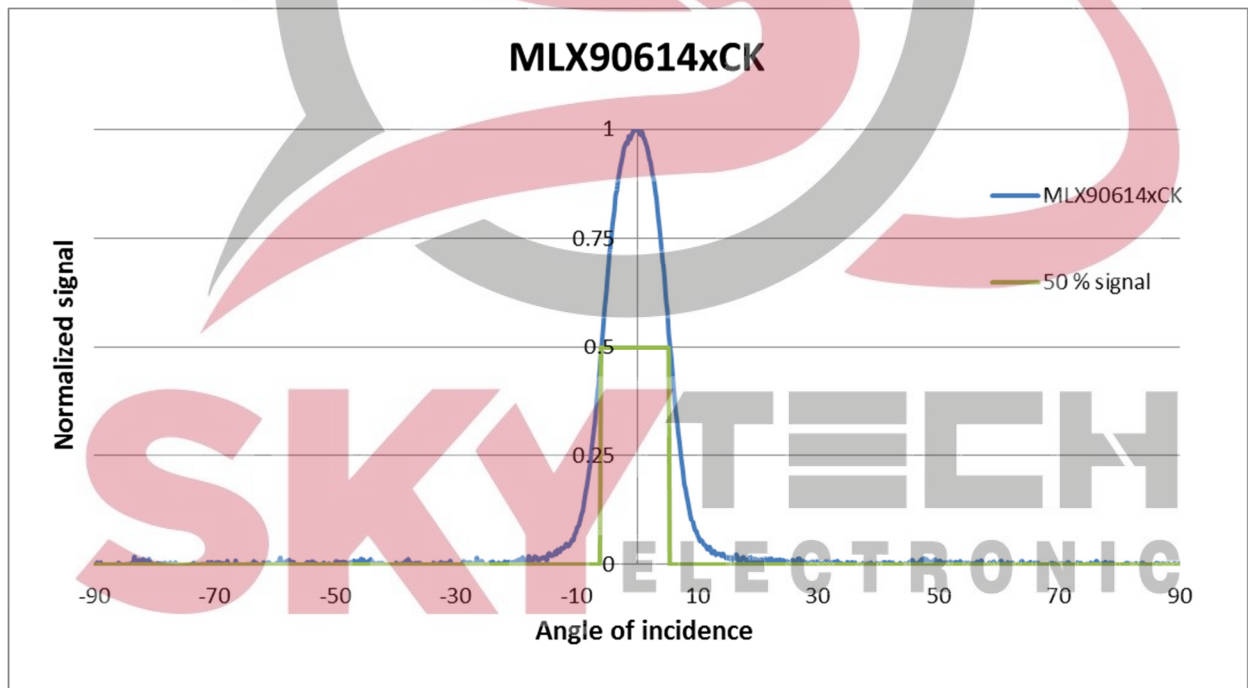

Figure 36 Typical FOV of MLX90614xCK type

## 11. Applications Information

### 11.1. Use of the MLX90614 thermometer in SMBus configuration

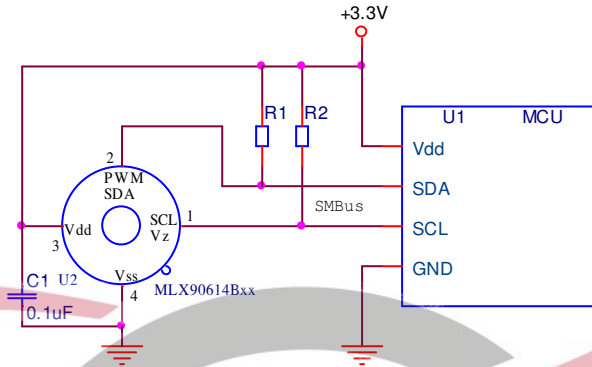

Figure 37: MLX90614 SMBus connection

Figure 37 shows the connection of a MLX90614 to a SMBus with 3.3V power supply. The MLX90614 has diode clamps SDA / SCL to Vdd so it is necessary MLX90614 to be powered in order not to load the SMBus lines.

### 11.2. Use of multiple MLX90614s in SMBus configuration

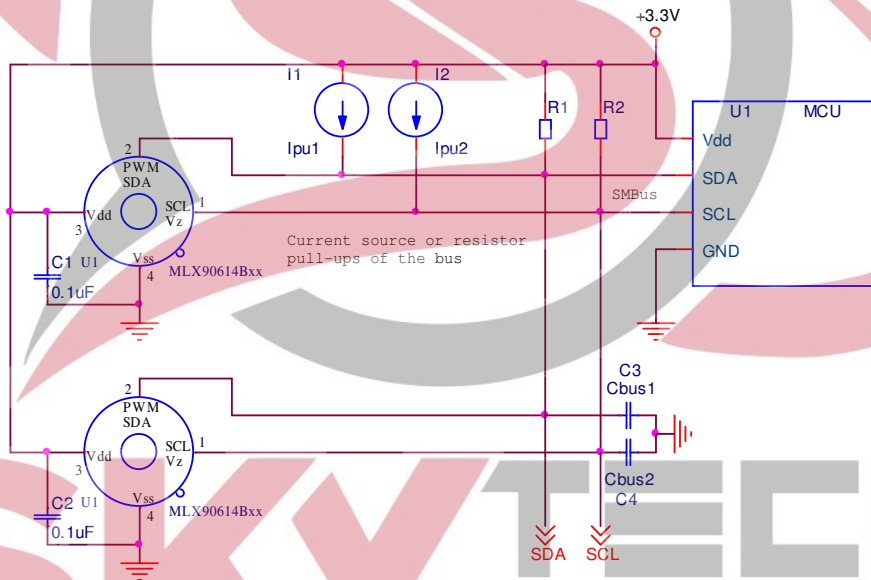

Figure 38: Use of multiple MLX90614 devices in SMBus network

The MLX90614 supports a 7-bit slave address in EEPROM, thus allowing up to 127 devices to be read via two common wires. With the MLX90614xBx this results in 254 object temperatures measured remotely and an additional 127 ambient temperatures which are also available. Current source pull-ups may be preferred with higher capacitive loading on the bus (C3 and C4 represent the lines' parasitic), while simple resistive pull-ups provide the obvious low cost advantage.

### 11.3. PWM output operation

Using the PWM output mode of the MLX90614 is very simple, as shown in Figure 39.

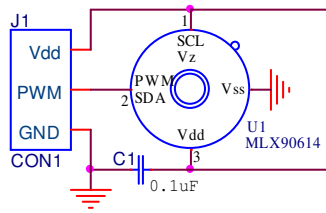

Figure 39: Connection of MLX90614 for PWM output mode

The PWM mode is free-running after POR when configured in EEPROM. The SCL pin must be forced high for PWM mode operation (can be shorted to V<sub>DD</sub> pin).

A pull-up resistor can be used to preserve the option for SMBus operation while having PWM as a default as is shown on Figure 40.

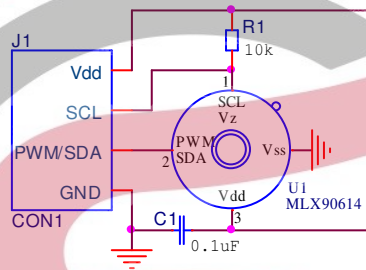

Figure 40: PWM output with SMBus available

Again, the PWM mode needs to be written as the POR default in EEPROM. Then for PWM operation the SCL line can be high impedance, forced high, or even not connected. The pull-up resistor R1 will ensure there is a high level on the SCL pin and the PWM POR default will be active. SMBus is still available (for example – for further reconfiguration of the MLX90614, or sleep mode power management) as there are pull-up resistors on the SMBus lines anyway.

PWM can be configured as open drain NMOS or a push-pull output. In the case of open drain external pull-up will be needed. This allows cheap level conversion to lower logic high voltage. Internal pull-ups present in many MCUs can also be used.

### 11.4. Thermal alert / thermostat

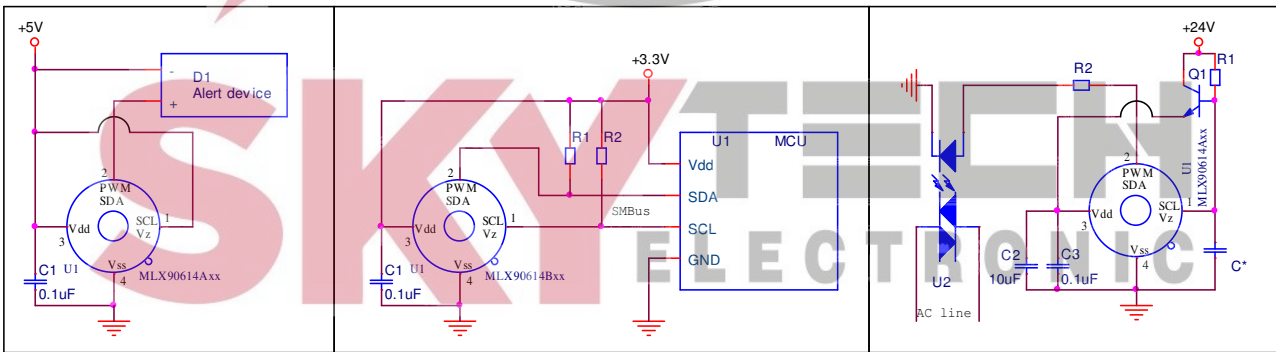

Figure 41: Thermal alert / thermostat applications of MLX90614

The MLX90614 can be configured in EEPROM to operate as a thermal relay. A non-contact freezing or boiling prevention with 1 mA quiescent current can be built with two components only – the MLX90614 and a capacitor. The PWM / SDA pin can be programmed as a push-pull or open drain NMOS, which can trigger an external device, such as a relay (refer to electrical specifications for load capability), buzzer, RF transmitter or a LED. This feature allows very simple thermostats to be built without the need of any MCU and zero design overhead required for firmware development. In conjunction with a MCU, this function can operate as a system alert that wakes up the MCU. Both object temperature and sensor die temperature can also be read in this configuration.



### 11.5. High voltage source operation

As a standard, the module MLX90614Axx works with a supply voltage of 5Volt. In addition, thanks to the integrated internal reference regulator available at pin SCL / Vz, this module can easily be powered from higher voltage source (like VDD=8...16V). Only a few external components as depicted in the diagram below are required to achieve this.

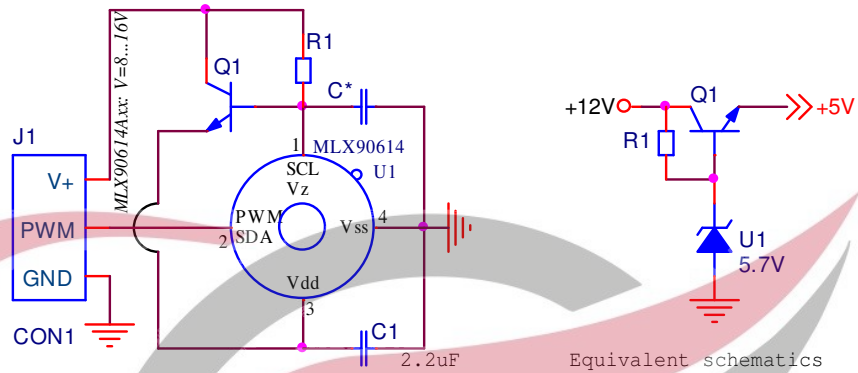

Figure 42: 12V regulator implementation

With the second (synthesized Zener diode) function of the SCL / Vz pin used, the 2-wire interface function is available only if the voltage regulator is overdriven (5V regulated power is forced to Vdd pin).



## 12. Application Comments

Significant **contamination** at the optical input side (sensor filter) might cause unknown additional filtering/distortion of the optical signal and therefore result in unspecified errors.

IR sensors are inherently susceptible to errors caused by **thermal gradients**. There are physical reasons for these phenomena and, in spite of the careful design of the MLX90614, it is recommended not to subject the MLX90614 to heat transfer and especially transient conditions.

Upon **power-up** the MLX90614 passes embedded checking and calibration routines. During these routines the output is not defined and it is recommended to wait for the specified POR time before reading the module. Very slow power-up may cause the embedded POR circuitry to trigger on inappropriate levels, resulting in unspecified operation and this is not recommended.

The MLX90614 is designed and calibrated to operate as a non-contact thermometer in **settled conditions**. Using the thermometer in a very different way will result in unknown results.

**Capacitive loading on a SMBus** can degrade the communication. Some improvement is possible with use of current sources compared to resistors in pull-up circuitry. Further improvement is possible with specialized commercially available bus accelerators. With the MLX90614 additional improvement is possible by increasing the pull-up current (decreasing the pull-up resistor values). Input levels for SMBus compatible mode have higher overall tolerance than the SMBus specification, but the output low level is rather low even with the high-power SMBus specification for pull-up currents. Another option might be to go for a slower communication (clock speed), as the MLX90614 implements Schmidt triggers on its inputs in SMBus compatible mode and is therefore not really sensitive to rise time of the bus (it is more likely the rise time to be an issue than the fall time, as far as the SMBus systems are open drain with pull-up).

For **ESD protection** there are clamp diodes between the Vss and Vdd and each of the other pins. This means that the MLX90614 might draw current from a bus in case the SCL and/or SDA is connected and the Vdd is lower than the bus pull-ups' voltage.

In **12V powered systems SMBus usage is constrained** because the SCL pin is used for the Zener diode function. Applications where the supply is higher than 5V should use the PWM output or an external regulator. Nevertheless, in the 12V powered applications MLX90614 can be programmed (configured and customized) by forcing the Vdd to 5V externally and running the SMBus communication.

**A sleep mode** is available in the MLX90614Bxx. This mode is entered and exited via the SMBus compatible 2-wire communication. On the other hand, the extended functionality of the SCL pin yields in increased leakage current through that pin. As a result, this pin needs to be forced low in sleep mode and the pull-up on the SCL line needs to be disabled in order to keep the overall power drain in sleep mode really small. During sleep mode the sensor will not perform measurements.

The **PWM pin is not designed for direct drive of inductive loads** (such as electro-magnetic relays). Some drivers need to be implemented for higher load, and auxiliary protection might be necessary even for light but inductive loading.

It is possible to use the MLX90614 in applications, powered directly from the AC line (transformer less). In such cases it is very important not to forget that **the metal package of the sensor is not isolated** and therefore may occur to be connected to that line, too. Melexis cannot be responsible for any application like this and highly recommends not using the MLX90614 in that way.

**Power dissipation** within the package may affect performance in two ways: by heating the "ambient" sensitive element significantly beyond the actual ambient temperature, as well as by causing gradients over the package that will inherently cause thermal gradient over the cap. Loading the outputs also causes increased power dissipation. In case of using the MLX90614Axx internal Zener voltage feature, the regulating external transistor should also not cause heating of the TO39 package.

## MLX90614 family

Single and Dual Zone  
Infra Red Thermometer in TO-39

**High capacitive load on a PWM line** will result in significant charging currents from the power supply, bypassing the capacitor and therefore causing EMC, noise, level degradation and power dissipation problems. A simple option is adding a series resistor between the PWM / SDA pin and the capacitive loaded line, in which case timing specifications have to be carefully reviewed. For example, with a PWM output that is set to 1.024ms and the output format that is 11 bit, the time step is 0.5 $\mu$ s and a settling time of 2 $\mu$ s would introduce a 4 LSB error.

**Power supply decoupling** capacitor is needed as with most integrated circuits. MLX90614 is a mixed-signal device with sensors, small signal analog part, digital part and I/O circuitry. In order to keep the noise low power supply switching noise needs to be decoupled. High noise from external circuitry can also affect noise performance of the device. In many applications a 100nF SMD ceramic capacitor close to the Vdd and Vss pins would be a good choice. It should be noted that not only the trace to the Vdd pin needs to be short, but also the one to the Vss pin. Using MLX90614 with short pins improves the effect of the power supply decoupling.

Severe noise can also be coupled within the package from the SCL (in worst cases also from the SDA) pin. This issue can be solved by using PWM output. Also the PWM output can pass additional filtering (at lower PWM frequency settings). With a simple LPF RC network added also increase of the ESD rating is possible.

Check [www.melexis.com](http://www.melexis.com) for most recent application notes about MLX90614.



## 13. Standard information regarding manufacturability of Melexis products with different soldering processes

Our products are classified and qualified regarding soldering technology, solderability and moisture sensitivity level according to following test methods:

### Wave Soldering THD's (Through Hole Devices)

- EIA/JEDEC JESD22-B106 and EN60749-15  
Resistance to soldering temperature for through-hole mounted devices

### Iron Soldering THD's (Through Hole Devices)

- EN60749-15  
Resistance to soldering temperature for through-hole mounted devices

### Solderability THD's (Through Hole Devices)

- EIA/JEDEC JESD22-B102 and EN60749-21  
Solderability

For all soldering technologies deviating from above mentioned standard conditions (regarding peak temperature, temperature gradient, temperature profile etc) additional classification and qualification tests have to be agreed upon with Melexis.

Melexis is contributing to global environmental conservation by promoting **lead free** solutions. For more information on qualifications of **RoHS** compliant products (RoHS = European directive on the Restriction Of the use of certain Hazardous Substances) please visit the quality page on our website: <http://www.melexis.com/quality.aspx>

**The MLX90614 is RoHS compliant**

## 14. ESD Precautions

Electronic semiconductor products are sensitive to Electro Static Discharge (ESD). Always observe Electro Static Discharge control procedures whenever handling semiconductor products.

**SKY** **TECH**  
**ELECTRONIC**

## 15. FAQ

**When I measure aluminum and plastic parts settled at the same conditions I get significant errors on aluminum.**

### Why?

Different materials have different **emissivity**. A typical value for aluminum (roughly polished) is 0.18 and for plastics values of 0.84...0.95 are typical. IR thermometers use the radiation flux between the sensitive element in the sensor and the object of interest, given by the equation

$$q = \epsilon_1 \times \alpha_1 \times (T_1^4) \times \sigma \times A_1 \times F_{a-b} - \epsilon_2 \times (T_2^4) \times \sigma \times A_2,$$

Where:

$\epsilon_1$  and  $\epsilon_2$  are the emissivities of the two objects,

$\alpha_1$  is the absorptivity of the sensor (in this case),

$\sigma$  is the Stefan-Boltzmann constant,

$A_1$  and  $A_2$  are the surface areas involved in the radiation heat transfer,

$F_{a-b}$  is the shape factor,

$T_1$  and  $T_2$  are known temperature of the sensor die (measured with specially integrated and calibrated element) and the object temperature that we need.

Note that these are all in Kelvin, heat exchange knows only physics.

When a body with low emissivity (such as aluminum) is involved in this heat transfer, the portion of the radiation incident to the sensor element that really comes from the object of interest decreases – and the reflected environmental IR emissions take place. (This is all for bodies with zero transparency in the IR band.) The IR thermometer is calibrated to stay within specified accuracy – but it has no way to separate the incoming IR radiation into real object and reflected environmental part. Therefore, measuring objects with low emissivity is a very sophisticated issue and infra-red measurements of such materials are a specialized field.

What can be done to solve that problem? Look at paintings – for example, oil paints are likely to have emissivity of 0.85...0.95 – but keep in mind that the stability of the paint emissivity has inevitable impact on measurements.

It is also a good point to keep in mind that not everything that looks black is “black” also for IR. For example, even heavily oxidized aluminum has still emissivity as low as 0.30.

How high is enough? Not an easy question – but, in all cases the closer you need to get to the real object temperature the higher the needed emissivity will be, of course.

With the real life emissivity values the environmental IR comes into play via the reflectivity of the object (the sum of Emissivity, Reflectivity and Absorptivity gives 1.00 for any material). The larger the difference between environmental and object temperature is at given reflectivity (with an opaque for IR material reflectivity equals 1.00 minus emissivity) the bigger errors it produces.

**After I put the MLX90614 in the dashboard I start getting errors larger than specified in spite that the module was working properly before that. Why?**

Any object present in the FOV of the module provides IR signal. It is actually possible to introduce error in the measurements if the module is attached to the dashboard with an opening that enters the FOV. In that case portion of the dashboard opening will introduce IR signal in conjunction with constraining the effective FOV and thus compromising specified accuracy. Relevant opening that takes in account the FOV is a must for accurate measurements. Note that the basic FOV specification takes 50% of IR signal as threshold (in order to define the area, where the measurements are relevant), while the entire FOV at lower level is capable of introducing lateral IR signal under many conditions.



## MLX90614 family

Single and Dual Zone  
Infra Red Thermometer in TO-39

### **When a hot (cold) air stream hits my MLX90614 some error adds to the measured temperature I read. What is it?**

IR sensors are inherently sensitive to difference in temperatures between the sensitive element and everything incident to that element. As a matter of fact, this element is not the sensor package, but the sensor die inside. Therefore, a thermal gradient over the sensor package will inevitably result in additional IR flux between the sensor package and the sensor die. This is real optical signal that cannot be segregated from the target IR signal and will add errors to the measured temperature.

Thermal gradients with impact of that kind are likely to appear during transient conditions. The sensor used is developed with care about sensitivity to this kind of lateral phenomena, but their nature demands some care when choosing place to use the MLX90614 in order to make them negligible.

### **I measure human body temperature and I often get measurements that significantly differ from the +37°C I expect.**

IR measurements are true surface temperature measurements. In many applications this means that the actual temperature measured by an IR thermometer will be temperature of the clothing and not the skin temperature. Emissivity (explained first in this section) is another issue with clothes that has to be considered.

There is also the simple chance that the measured temperature is adequate – for example, in a cold winter human hand can appear at temperatures not too close to the well-known +37°C.

### **I consider using MLX90614AAA to measure temperature within car compartment, but I am embarrassed about the Sun light that may hit the module. Is it a significant issue?**

Special care is taken to cut off the visible light spectra as well as the NIR (near IR) before it reaches the sensitive sensor die. Even more, the glass (in most cases) is not transparent to the IR radiation used by the MLX90614. Glass has temperature and really high emissivity in most cases – it is “black” for IR of interest. Overall, Sun behind a window is most likely to introduce relatively small errors. Why is it not completely eliminated after all? Even visible light partially absorbed in the filter of the sensor has some heating potential and there is no way that the sensor die will be “blind” for that heating right in front of it.

The logo for SKYTECH ELECTRONIC features the word "SKY" in a large, bold, pink font, followed by "TECH" in a smaller, bold, grey font. Below "TECH" is the word "ELECTRONIC" in a smaller, bold, grey font. The entire logo is set against a background of a large, stylized, abstract graphic consisting of several overlapping, curved, pink and grey shapes that resemble a stylized 'S' or a dynamic, flowing pattern.

## 16. Package Information

### 16.1. MLX90614xxA

The MLX90614 is packaged in an industry standard TO39 can.

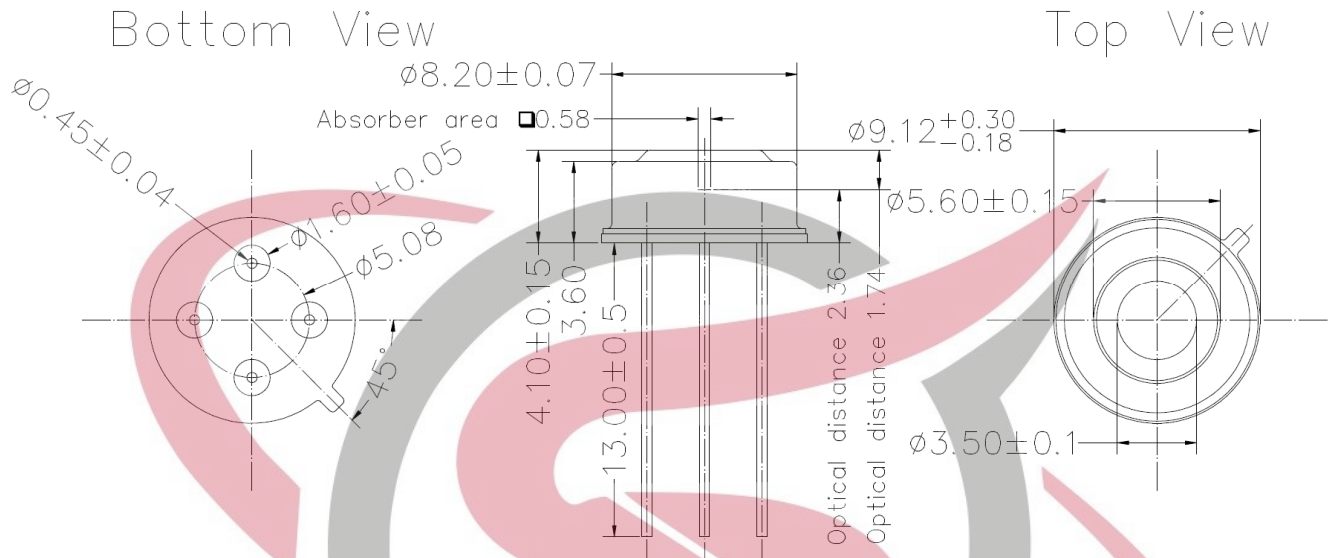

Figure 43: MLX90614xxA package

Note: All dimensions are in mm

### 16.2. MLX90614xCC

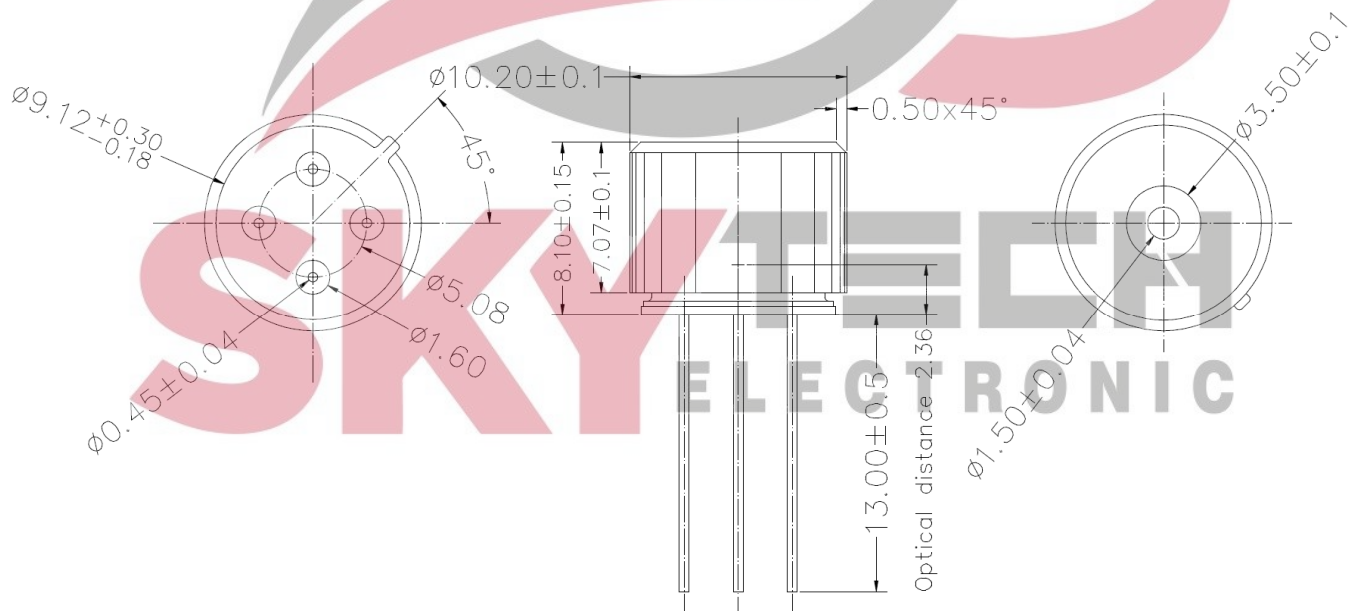

Figure 44: MLX90614xCC package

**16.3. MLX90614xCF**

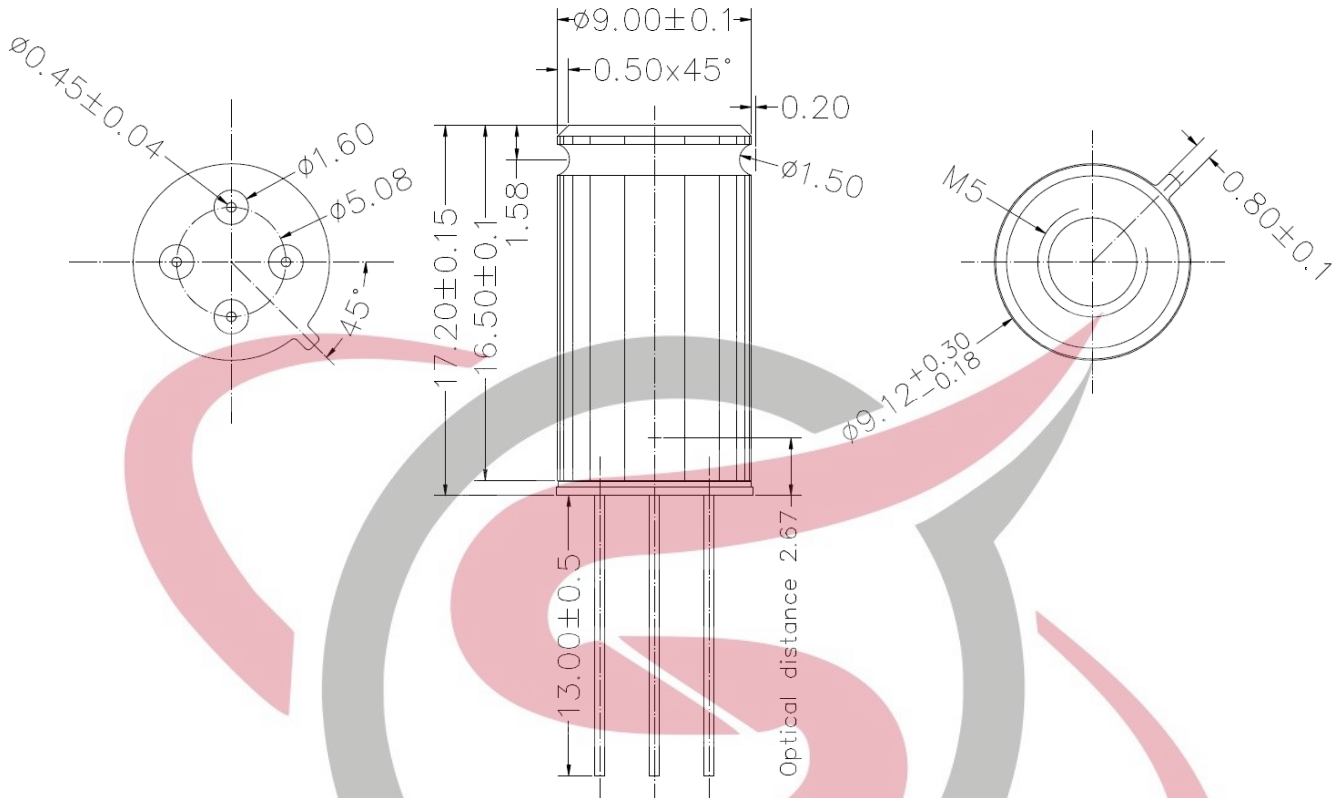

Figure 45: MLX90614xCF package

**16.4. MLX90614xCH**

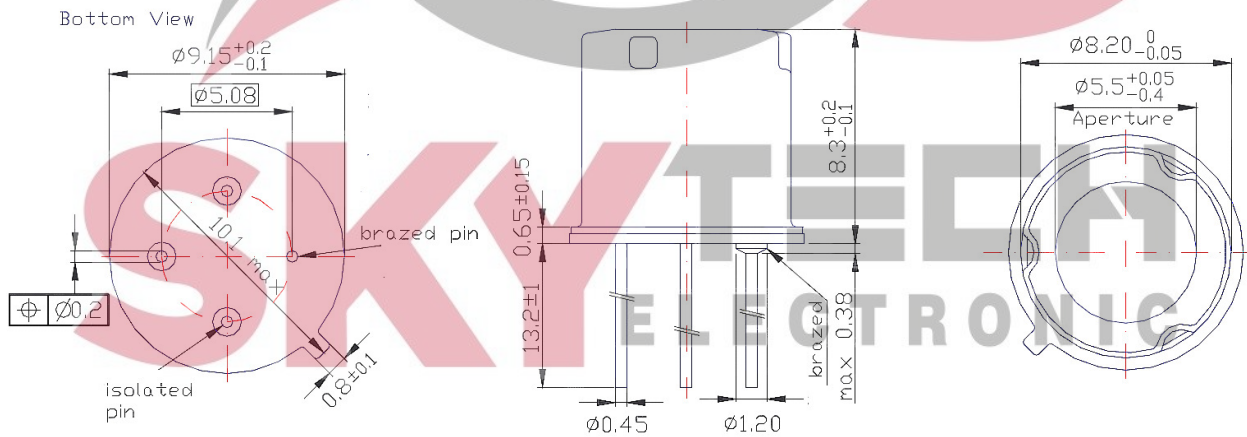

Figure 46: MLX90614xCH package



## 16.7. Part marking

The MLX90614 is laser marked with 10 symbols. First 3 letters define device version (AAA, BCC, etc), and the last 7 are the lot number. Example: "ACC9307308" – MLX90614ACC from lot 9307308.

## 16.8. Operating and storage humidity range

Operating and storage humidity range is defined as 85% non-condensing humidity.





## 17. Table of figures

Figure 1: Typical application schematics.....	2
Figure 2: Pin description .....	8
Figure 3: Block diagram .....	13
Figure 4: SMBus packet element key.....	18
Figure 5: SMBus read word format.....	19
Figure 6: SMBus write word format.....	19
Figure 7: Recommended timing on SMBus.....	19
Figure 8: Read word format (SA=0x5A, read RAM=0x07, result=0x3AD2, PEC=0x30).....	20
Figure 9: Write word format (SA=0x5A, write EEPROM=0x02, data=0xC807, PEC=0x48) .....	20
Figure 10: SMBus timing specification and definition.....	21
Figure 11: Enter sleep mode command (SA = 0x5A, Command = 0xFF, PEC = 0xE8).....	22
Figure 12: Exit Sleep Mode .....	22
Figure 13: Undershoot of SCL line due to on chip synthesized Zener diode (5V versions only) .....	23
Figure 14: PWM timing single (above) and extended PWM (bellow).....	24
Figure 15: PWM example single mode.....	25
Figure 16: Extended PWM format with DUAL [5:1] = 01h (2 repetitions for each data) .....	26
Figure 17: Example: Extended PWM mode readings – sensor 1 above and sensor 2 bellow .....	26
Figure 18: Switching from PWM mode to SMBus .....	29
Figure 19: Request (switch to SMBus) condition .....	29
Figure 20: Software flow .....	32
Figure 21: Thermal relay: “PWM” pin versus Tobj .....	32
Figure 22: Accuracy of MLX90614 (Ta, To) except for xCK type .....	34
Figure 23 Accuracy of MLX90614xCK (Ta, To) only .....	35
Figure 24: Accuracy of MLX90614DAA (Ta, To) for medical applications. Accuracy of the MLX90614DCC, DCH and DCI for VDD = 3V (see paragraph 10.1.3).....	36
Figure 25: Typical Ta dependence from supply voltage .....	37
Figure 26: Typical To dependence from supply voltage (practically the same as Ta dependence error .....	37
Figure 27: Typical To compensated dependence error .....	37
Figure 28: Field Of View measurement.....	38
Figure 29: Typical FOV of MLX90614xAA .....	38
Figure 30: Typical FOV of MLX90614xBA.....	39
Figure 31: Identification of zone 1&2 relative to alignment tab.....	39
Figure 32: Typical FOV of MLX90614xCC.....	39
Figure 33: Typical FOV of MLX90614xCF.....	40
Figure 34: Typical FOV of MLX90614xCH.....	40
Figure 35: Typical FOV of MLX90614xCI.....	41
Figure 36 Typical FOV of MLX90614xCK type .....	41
Figure 37: MLX90614 SMBus connection.....	42
Figure 38: Use of multiple MLX90614 devices in SMBus network .....	42
Figure 39: Connection of MLX90614 for PWM output mode .....	43
Figure 40: PWM output with SMBus available .....	43
Figure 41: Thermal alert / thermostat applications of MLX90614.....	43
Figure 42: 12V regulator implementation.....	44
Figure 43: MLX90614xxA package .....	50
Figure 44: MLX90614xCC package .....	50
Figure 45: MLX90614xCF package .....	51
Figure 46: MLX90614xCH package.....	51
Figure 47: MLX90614xCI package .....	52
Figure 48 MLX90614xCK package .....	52

## 18. References

[1] **System Management Bus (SMBus) Specification** Version 2.0 August 3, 2000  
SBS Implementers Forum Copyright . 1994, 1995, 1998, 2000  
Duracell, Inc., Energizer Power Systems, Inc., Fujitsu, Ltd., Intel Corporation, Linear Technology Inc., Maxim Integrated Products, Mitsubishi Electric Semiconductor Company, PowerSmart, Inc., Toshiba Battery Co. Ltd., Unitrode Corporation, USAR Systems, Inc.



## 19. Contact

For the latest version of this document, go to our website at [www.melexis.com](http://www.melexis.com).

For additional information, please contact our Direct Sales team and get help for your specific needs:

Europe, Africa	Telephone: +32 13 67 04 95
	Email : sales_europe@melexis.com
Americas	Telephone: +1 603 223 2362
	Email : sales_usa@melexis.com
Asia	Email : sales_asia@melexis.com

## 20. Disclaimer

The information furnished by Melexis herein ("Information") is believed to be correct and accurate. Melexis disclaims (i) any and all liability in connection with or arising out of the furnishing, performance or use of the technical data or use of the product(s) as described herein ("Product") (ii) any and all liability, including without limitation, special, consequential or incidental damages, and (iii) any and all warranties, express, statutory, implied, or by description, including warranties of fitness for particular purpose, non-infringement and merchantability. No obligation or liability shall arise or flow out of Melexis' rendering of technical or other services.

The Information is provided "as is" and Melexis reserves the right to change the Information at any time and without notice. Therefore, before placing orders and/or prior to designing the Product into a system, users or any third party should obtain the latest version of the relevant information to verify that the information being relied upon is current. Users or any third party must further determine the suitability of the Product for its application, including the level of reliability required and determine whether it is fit for a particular purpose.

The Information is proprietary and/or confidential information of Melexis and the use thereof or anything described by the Information does not grant, explicitly or implicitly, to any party any patent rights, licenses, or any other intellectual property rights.

This document as well as the Product(s) may be subject to export control regulations. Please be aware that export might require a prior authorization from competent authorities. The Product(s) are intended for use in normal commercial applications. Unless otherwise agreed upon in writing, the Product(s) are not designed, authorized or warranted to be suitable in applications requiring extended temperature range and/or unusual environmental requirements. High reliability applications, such as medical life-support or life-sustaining equipment are specifically not recommended by Melexis.

The Product(s) may not be used for the following applications subject to export control regulations: the development, production, processing, operation, maintenance, storage, recognition or proliferation of 1) chemical, biological or nuclear weapons, or for the development, production, maintenance or storage of missiles for such weapons; 2) civil firearms, including spare parts or ammunition for such arms; 3) defense related products, or other material for military use or for law enforcement; 4) any applications that, alone or in combination with other goods, substances or organisms could cause serious harm to persons or goods and that can be used as a means of violence in an armed conflict or any similar violent situation.

The Products sold by Melexis are subject to the terms and conditions as specified in the Terms of Sale, which can be found at <https://www.melexis.com/en/legal/terms-and-conditions>.

This document supersedes and replaces all prior information regarding the Product(s) and/or previous versions of this document.

Melexis NV © - No part of this document may be reproduced without the prior written consent of Melexis. (2019)

ISO/TS 16949 and ISO14001 Certified

SKY TECH  
ELECTRONIC

**MLX90614 family**Single and Dual Zone  
Infra Red Thermometer in TO-39

Revisions Table

Version	Changes	Remark	Date
001		Preliminary Release	Not on doc-server
002	- ordering info (p.1): maximum ratings, accuracy section - added PWM connection, Application section - remade single zone FOV - added PWM details, p. 31 - remove text "filter outside option" - wake-up time (page 17) increased from 13 to 80 ms		27 Feb 2007
003	Added 35 deg. FOV 90614xxC version, FOV specification corrected and FOV chart's style unified, examples errors corrected (Ta in RAM), factory default (SMBus) clarified, Pin states (SDA/PWM automatically switches to NMOS Open Drain when SMBus mode is entered), Application Schematic 10.1 corrected (components' references U1 U1 changed to U1 U2), emissivity coefficient format in EEPROM explained, erase before write in EEPROM note added (write 0x0000 first), small grammar and spelling corrections		17 Aug 2007
004	Added gradient compensated 90614xCC version. Added 10 deg. FOV 90614xCF version. Added FOV specification of the 90614xCF. Clarified PWM period EEPROM configuration. Clarified flags read through SMBus. Added drawing of the 90614xCF.		09 Jun 2008
005	Some electrical parameters corrected overall revision.		03 May 2009
006	Review of electrical parameters, added xCH and xCI parts and their specific parameters, PWM graphs and examples review, added VDD dependence of ambient channel, Application comments update with high speed readings with SMBus, table of figures added		12 Oct 2010
008	Changed first page according to new rules. Added DCh and DCI filter settings. Added note for limitation of highest To of DCh and DCH. Read write examples are changed to be with SA=0x5A. Better description of SCL low during sleep. Some parameters are corrected: Oscillator deviation, Timeout (L and H). Added optical distance for some devices (where applicable). Overall revision.		29 Aug 2012
009	Added -DCC version in ASTM statement on page 33 and in filter settings table 10. Page 2: changed from germanium to silicon lens.		29 June 2015
010	Added xCK versions. Correct PMW to PWM. TO39 base dimension updated: $\varnothing 9.12 \pm 0.075 \rightarrow \varnothing 9.12 \pm 0.18$		09 June 2017
011	Drawing dimension xCK corrected		20 March 2018
012	Custom version		29 July 2019
013	TO39 base dimension updated: changed from $\varnothing 9.12 \pm 0.18$ to $\varnothing 9.12 + 0.30 / - 0.18$ , added EEPROM write sequence		03 Sept 2019